

AZ ÚJ PORTFÓLIÓ ÁTTEKINTÉSE

LEDVANCE LED SZALAG RENDSZEREK

2022. MÁRCIUS

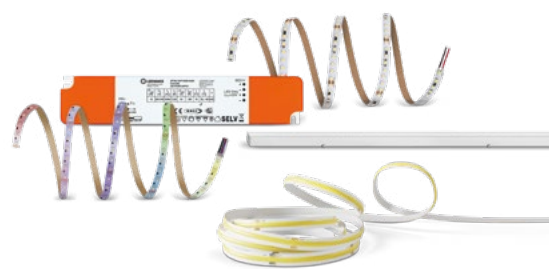

LEDVANCE.HU



LEDVANCE

LEDVANCE: ADVANCING LIGHT

BAD LIGHT MAKES YOU UNPREDICTABLE? WE'VE GOT A SOLUTION FOR THAT!

With over 100 years of experience in general lighting, LEDVANCE combines traditional lighting technology with pioneering lighting innovations for almost any application. In addition to this unique know-how, we particularly rely on long-term customer relationships and a strong global sales network.

As technology trend experts, we are leading the way in meeting the rapidly changing demands for high-quality and long-lasting light. And as a strong local partner, we are always reliably at your side in over 140 countries.

Whether it's luminaires, lamps, our LED Strip System or state-of-the-art light management solutions, our teams of specialists are focused on the specific needs of our customers. We are making a decisive contribution to increasing your competitiveness with technical innovations and easy-to-use, intelligent lighting solutions compliant with EU regulations.

That's why the new generation of our LED Strips is even more powerful and, above all, more versatile. Numerous accessories provide you with professional solutions for your various requirements and projects. The LED Strip system can be integrated into the VIVARES lighting management system and the components of the LED Strip TW KIT can also be combined with BIOLUX HCL. The COB LED Strips with their impressively uniform light without visible LED dots put the finishing touches on ambitious lighting design.

We always focus on the benefit for you as a lighting professional. That's why we do everything we can to make our products and systems particularly easy to plan, install and combine.

Based on these principles, we will continue to develop sophisticated products and provide you with optimum support in your personal fight against bad light.

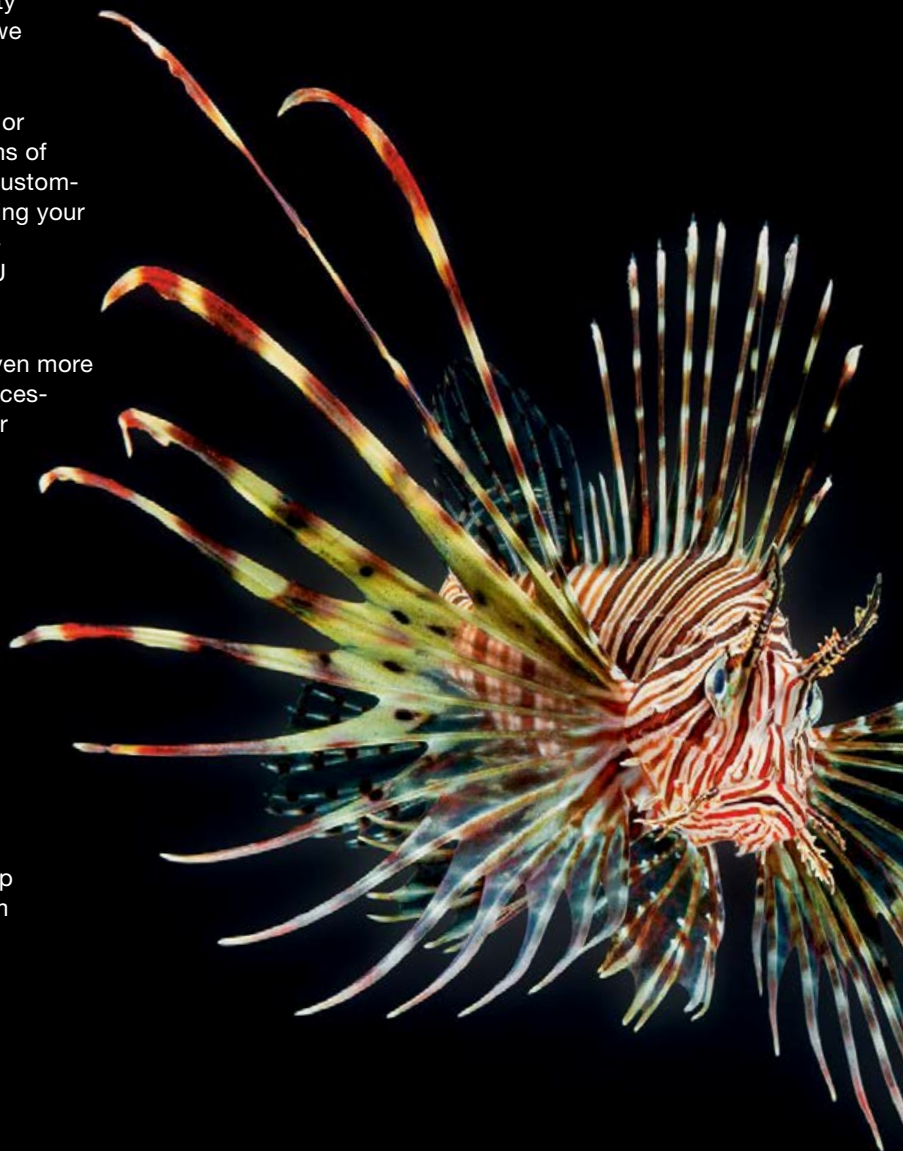

CONTENTS

LEDVANCE: ADVANCING LIGHT	02
AS FLEXIBLE AS YOUR DEMANDS	04
HUMAN CENTRIC LIGHTING WITH LED STRIPS	06
<hr/>	
APPLICATIONS FOR THE LED STRIPS	08
<hr/>	
SYSTEM COMPONENTS	12
SERVICE – CONFIGURATOR	13
SERVICE – INSTALLATION INSTRUCTIONS	14
<hr/>	
THE LED STRIP SYSTEM	
– LED STRIPS SUPERIOR CLASS TUNABLE WHITE	16
– LED STRIPS PERFORMANCE CLASS COB	20
– LED STRIPS PERFORMANCE CLASS	24
– LED STRIPS VALUE CLASS	34
– LED STRIPS PERFORMANCE CLASS RGBW	48
– LED STRIPS VALUE CLASS RGB	52
– STRIP ACCESSORIES	56
– PROFILES	60
– LED DRIVERS FOR CONSTANT VOLTAGE	67
<hr/>	
FEED LENGTHS	74
LIGHT MANAGEMENT SYSTEM	76
CASE STUDY: PROPYLAEA MUNICH	78
LIGHT PLANNING SUPPORT	79
ONLINE SERVICES	80
THE FULL LEDVANCE RANGE	81
NAMING IN THE LED STRIP SYSTEM	82
SYMBOLS AND ABBREVIATIONS	83



The pictures in the brochure are for illustration purposes only. All the technical parameters apply to the entire LED module. In view of the complex manufacturing process for light emitting diodes, the typical values given above for the technical LED parameters are merely statistical values that do not necessarily correspond to the actual technical parameters of an individual product; individual products may vary from the typical values.

AS FLEXIBLE AS YOUR D THE IMPROVED LEDVANCE

Easy to plan, easy to combine, easy to install. LED Strips from LEDVANCE have been making your day-to-day work easier for a long time. But with the latest generation of our intelligent LED Strip System, you can now complete your lighting projects even more easily and professionally – thanks to more power, more flexibility and more compatibility. And of course you can also rely on excellent customer service and a guarantee of up to 5 years¹.

MORE POWER

From lifetime, color rendering and protection classes to color consistency and guarantee periods, the new LEDVANCE LED Strips surpass the already excellent previous versions in each of these areas. Why? So that you can continue to set standards in your lighting projects. More power.

MORE HIGH-END

From now on, you can easily combine the LED strips with the comfortable VIVARES light management system and the flexible, powerful and extremely efficient Tunable White LED Strips with our award-winning BIOLUX human centric lighting. The LED Strip TW KIT includes all the components you need. Our COB LED Strips also offer you top performance. With their impressively uniform light without visible LED dots, they are the ideal choice for sophisticated lighting design. As you can see, with LEDVANCE you always have your finger on the pulse when it comes to lighting trends in the high-end sector.



MORE SUPPORT EVERY DAY

In addition to a broad portfolio of LED Strips that are prewired on both sides and tailor-made electronic components, LEDVANCE offers you useful online tools that make your day-to-day work even easier. The LED Strip System Configurator² guides you to success step by step. Our online training center has a variety of application-oriented eLearning activities in store for you including practical information on planning, product selection, installation and more. And you'll find even more tips on our YouTube channel.

Take a look at:



[ledvance.com/
led-strip-configurator](https://ledvance.com/led-strip-configurator)



training.ledvance.com



[ledvance.com/
LEDstripvideos](https://ledvance.com/LEDstripvideos)

EMANDS: LED STRIP SYSTEM

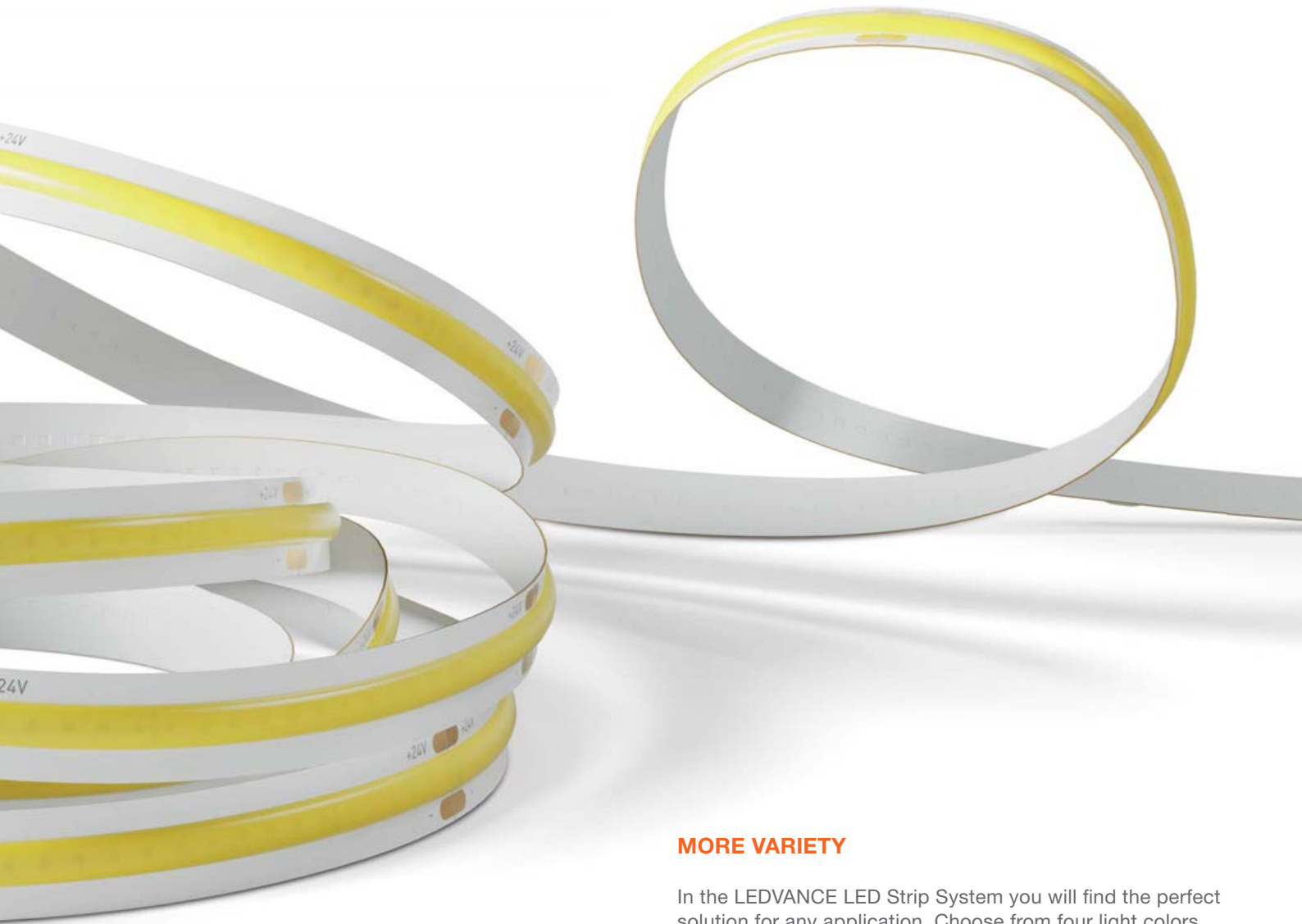

MORE VARIETY

In the LEDVANCE LED Strip System you will find the perfect solution for any application. Choose from four light colors between 2 700 K and 6 500 K and four luminous intensities between 500 lm/m and 2 000 lm/m. Expand your possibilities with Tunable White, RGBW and RGB strips as well as our drivers, profiles and accessories that are perfectly matched to one another following our modular principle.

2 700 K

4 000 K

6 500 K

Red

Green

Blue

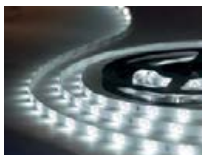

¹ For precise terms and conditions go to www.ledvance.com/guarantee

² The LED Strip System Configurator is no substitute for comprehensive professional planning with DIALux and RELUX or other professional light planning software

LIGHT WITH A BODY CLOCK

HUMAN CENTRIC LIGHTING

FOCUSING ON PEOPLE IN LIGHTING DESIGN

Light significantly influences our day-night cycle – our body clock – and therefore our health, well-being and performance. Human centric lighting (HCL) takes this biological effect into account. It simulates natural daylight throughout the day by gently changing color temperatures and illuminance levels. That's how even in dark rooms it creates a stimulating environment that boosts creative thinking as well as high levels of concentration at desks, in service sectors and in factories.



LEDVANCE BIOLUX HCL

The right light whatever the time of day. The LEDVANCE BIOLUX HCL system is easy to install and operate. It consists of a control unit and HCL-capable light sources and continuously adjusts the lighting to the time of day and the incidence of natural daylight. To cover individual needs even better, the system also offers a choice of different lighting profiles. BIOLUX has already proved its credentials by winning various design, function and innovation awards.



HCL HAS A POSITIVE EFFECT ON PEOPLE – ALSO IN TERMS OF ECONOMY



↑ 12%

OFFICE

12% higher employee performance in offices



↑ 18%

PRODUCTION

Worker productivity increases by up to 18%



↑ 14%

EDUCATION

14% improvement in learning and better grades

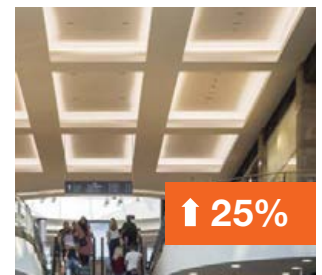

↑ 25%

RETAIL

Up to 25% increase in sales

Source: www.ecodesignconsultants.co.uk/healthy-buildings/

AN EFFECTIVE COMBINATION HCL AND TUNABLE WHITE LED STRIPS

You'll find more information about LEDVANCE Tunable White LED Strips from page 16.

The LEDVANCE Tunable White LED Strips can vary the color temperature dynamically and seamlessly from cozy warm white 2700 kelvin to activating cold white 6500 kelvin. This makes them ideal for simulating natural daylight from early morning to late evening.



COMFORT FOR LARGE ROOMS: VIVARES HCL

VIVARES HCL is the first choice for open-plan offices and floor solutions. The innovative light management system can overcome even complex challenges and is easy to install and operate.



ONE ROOM, ONE SYSTEM: BIOLUX HCL

The combination of a BIOLUX HCL Control Unit with panels and Tunable White LED Strips is the solution for implementing effective HCL in individual offices and other singular applications.



WELL PROTECTED FOR EVERY OCCASION

Tunable White LED Strips are also available in IP67-protected versions. This extends their range of applications for HCL solutions still further.

THE CONNECTION BIOLUX HCL LED STRIP KIT

The components in the BIOLUX HCL LED Strip KIT link the Tunable White LED Strips to the BIOLUX HCL Control Unit or the VIVARES HCL system. Of course, the components of the kit are also available separately.

Both kits at a glance:

BIOLUX HCL LS S TW ZB KIT 4058075671270

BIOLUX HCL LS S TW IP67 ZB KIT 4058075671294



OSRAM ZB 3.0 DALI CONV LI

LEDVANCE LED Strip 2700-6500K



OSRAM DALI TW driver

Products of OSRAM GmbH, distributed by LEDVANCE



BRILLIANT TALENTS

LEDVANCE LED STRIPS

IN VARIOUS PROJECTS

Used as general, cove or accent lighting, the LEDVANCE LED Strip System is a fascinatingly flexible solution that fits into many different lighting scenarios. It creates a stylish atmosphere in the gastronomy and hospitality sectors, and functional, efficient lighting in offices and sanitary facilities. And in shops it guides customers' eyes and creates desire. Thanks to the new HCL kit, Tunable White LED Strips can even simulate natural daylight.

Check out our [sample applications for your own projects and be inspired.](#)

1. LOBBIES

The lobby is a building's business card. LED Strips welcome visitors with their warm light. A combination of direct and indirect lighting combines an imposing atmosphere with high functionality. Light lines discreetly emphasize the architecture and point to walkways. The COB LED Strip without visible LED dots is particularly impressive on glossy surfaces.



LED STRIPS: Performance Class COB 1 000 lm/m, 4 000 K, LS PFM-1000/COB/940/5
PROFILE: Flat U-Shape Wing Profile (12 mm wide)
COVER: diffuse, LS AY-PC/R01/D/1
DRIVER: DR DALI-SUP-45/220-240/24

2. OFFICES

Visual comfort during changing activities, individual lighting requirements and modern design – Tunable White LED Strips perform numerous tasks in offices. Integrated in suspended ceilings, they illuminate offices and workplaces without glare. Their color temperature can be adjusted via a touch panel. And with the new TW KIT and BIOLUX HCL you can even provide human centric lighting.



LED STRIPS: Superior Class Tunable White 2 000 lm/m, LS SUP-2000/TW/927-965/5
PROFILE: Wide U-Shape Profile (26 mm high)
COVER: clear, LS AY-PC/W02/C/1
DRIVER: DR SUP-200/220-240/24
CONTROLLER: LC RF Controller 24 V RGBW/TW
TOUCH PANEL: Touch Panel TW, LC RF TOUCH PANEL TW



3

3. CEILING LIGHTING

Powerful LED Strips as ceiling lighting allow you to illuminate rooms without glare and in high quality. Their warm color temperature supports the effect in the room and ensures a stylish atmosphere. LED Strips bring out modern ceiling solutions particularly well.



LED STRIPS: Performance Class 2 000 lm/m, 3 000 K, LS P-2000/930/5
PROFILE: Medium U-Shape Wing Profile (15.5 mm high), LS AY-PM04/UW/23X15,5/10/1
COVER: clear, LS AY-PC/R02/C/1
DRIVER: DR DALI-SUP-150/220-240/24



4

4. RESTAURANTS/CANTEENS

In gastronomy, a feel-good atmosphere is important. RGBW LED Strips add some atmospheric sparkle in different colors, creating inviting and modern ambient lighting. The warm white light color produces flattering general lighting – elegant and classy but also functional and efficient.



LED STRIPS: Performance Class RGBW, 1 000 lm/m, 3 000 K, LS PFM-1000/RGBW/830/5/IP66
PROFILE: Medium U-Shape Wing Profile (15.5 mm high), LS AY-PM04/UW/23X15,5/10/1
COVER: diffuse, LS AY-PC/R02/D/1
DRIVER: DR-VAL-150/220-240/24
CONTROLLER: LC RF Controller 24 V RGBW/TW
TOUCH PANEL: Touch Panel RGBW, LC RF TOUCH PANEL RGBW

5. COFFEE SHOPS

For all projects that need that extra splash of color, a dash of brilliance and a tad more imagination, there are RGB LED Strips. The different colors give each space a certain appeal. Which light is the coffee going to taste better in?



5



LED STRIPS: Value Class RGB, 500 lm/m, LS VAL-500/RGB/5
PROFILE: Wide U-Shape Profile, LS AY-PW01/U/26X8/14/1
COVER: diffuse, LS AY-PC/W01/D/1
DRIVER: DR-VAL-120/220-240/24
CONTROLLER: LC RF Controller 24 V RGBW/TW
REMOTE CONTROL: Remote Control RGBW, LC RF REMOTE RGBW

See pages 56–66 for accessories for strips and profiles.



6

6. SHOPS

Generating pure emotion in the showroom, light guides customers' eyes, creates desire and stages brand worlds. No wonder that LED Strips put on a big show here. They accentuate shelves, focus on products and illuminate the entire shop in discreet, indirect light as cove lighting.



LED STRIPS: Performance Class 1 000 lm/m, 4 000 K, LS P-1000/940/5

PROFILE: Medium U-Shape Wing Profile, LS AY-PM01/UW/21,5X12/10/1

COVER: diffuse, LS AY -PC/P02/D/1

DRIVER: DR-VAL-150/220-240/24

7. BARS

Here, LED Strips really have a chance to show off. The spectrum ranges from indirect, pleasantly warm basic lighting and highlighting counters and other interior elements to ambient lighting for bathing everything in a cozy glow. And they always combine high quality of light with durability and efficiency.



LED STRIPS: Performance Class 500 lm/m, 4 000 K, LS P-500/940/5.

Ceiling: Performance Class 1 500 lm/m, 4 000 K, LS P-1500/940/5

PROFILE: Wide U-Shape Profile, LS AY-PW01/U/26X8/14/1

COVER: diffuse, LS AY-PC/W01/D/1

DRIVER: DR-VAL-120/220-240/24

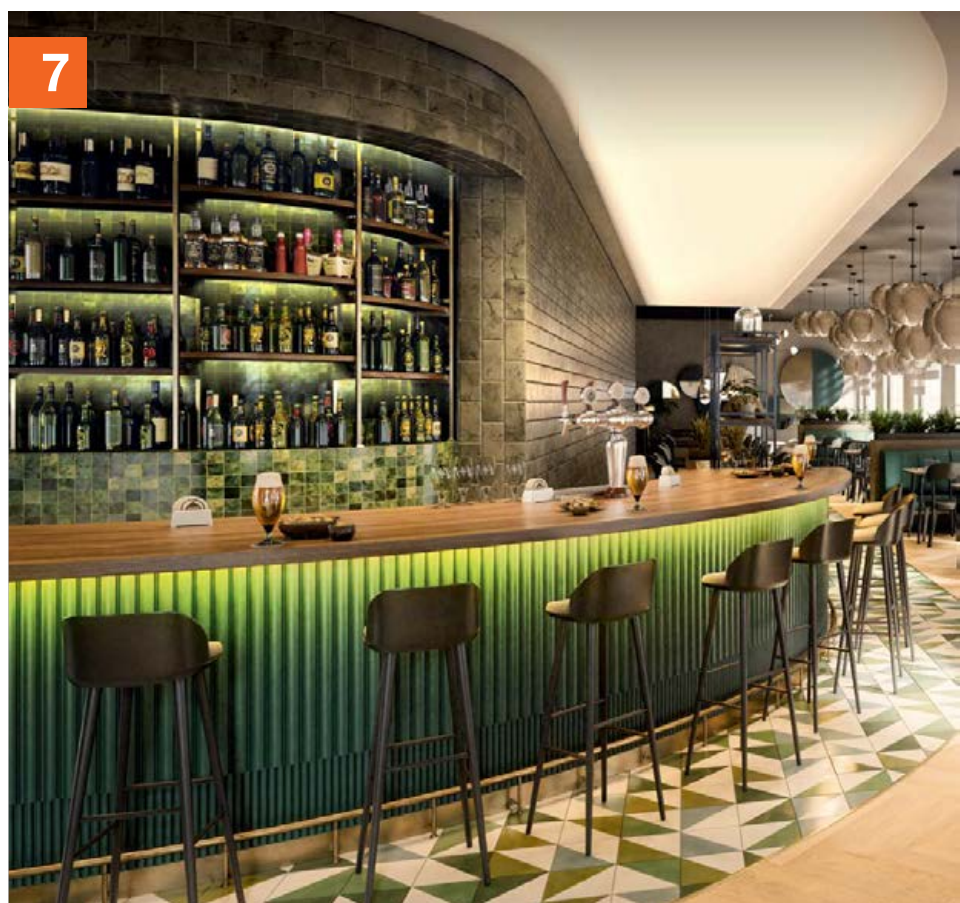

7



8

8. OUTDOOR STAIRS

Making a big entrance, LED Strips as IP67-protected versions are also talented outdoor performers. They enhance entrances and stairs in particular with their functional, aesthetic and efficient light. They not only create a greater feeling of safety but also help prevent accidents. And look good in the process.



LED STRIPS: Performance Class 1 000 lm/m, 4 000 K, IP67, LS P-1000/940/5/IP67

PROFILE: Medium Edge Shape Profile (12 mm wide), LS AY-PM06/E/18X18/12/1

COVER: diffuse, LS AY -PC/R01/D/1

DRIVER: DR DIM-PFM-250/220-240/24/P



9

9. CORRIDORS

Corridors connect rooms and different parts of the building. First and foremost, the lights need to provide orientation. LED Strips outline walkways, brighten the walls evenly and create a positive feeling of space without a tunnel effect.



LED STRIPS: Value Class 500 lm/m, 3000 K, LS V-500/830/5

PROFILE: Wide U-Shape Profile (26 mm high), LS AY-PW03/U/26X26/14/1

COVER: clear, LS AY-PC/W02/C/1

DRIVER: DR-VAL-150/220-240/24

For more information about our products, please visit [ledvance.com/led-strip](https://www.ledvance.com/led-strip)
For professional lighting design by LEDVANCE, please get in touch at:
Email: contact@ledvance.com
Phone: +49 89 780673-660



10. SANITARY FACILITIES

In washrooms and toilets, good light conveys cleanliness, hygiene and a pleasant ambience. LED Strips with a high IP66 rating are ideal for damp rooms, perfectly illuminate both washtops and mirrors and add the finishing touches with their sleek design.



LED STRIPS: Value Class 1500 lm/m, 4000 K, IP66, LS V-1500/840/5/IP66

PROFILE: ceiling: Wide U-Shape Profile (26 mm high), LS AY-PW03/U/26X26/14/1,
mirror: Flat U-Shape Wing Profile (12 mm wide), LS AY-PF03/UW/25X7/12/1

COVER: clear,
ceiling: LS AY-PC/W02/C/1,
mirror: LS AY-PC/R01/C/1

DRIVER: DR SUP-100/220-240/24



10

11. HOTEL ROOMS

Whether you're traveling for business, going on holiday or spending a romantic evening, you'll feel right at home in hotel rooms lit by LED Strips. Cleverly placed as accent lighting, their warm, diffuse light creates a homely atmosphere and makes sure your stay lingers long in your memory.



LED STRIPS: Performance Class 1000 lm/m, 2700 K, LS P-1000/927/5

PROFILE: Medium U-Shape Profile, LS AY-PM05/U/17,5X14,5/10/1

COVER: diffuse, LS AY-PC/R01/D/1

DRIVER: DR-SUP-100/220-240/24

See pages 56–66 for accessories for strips and profiles.

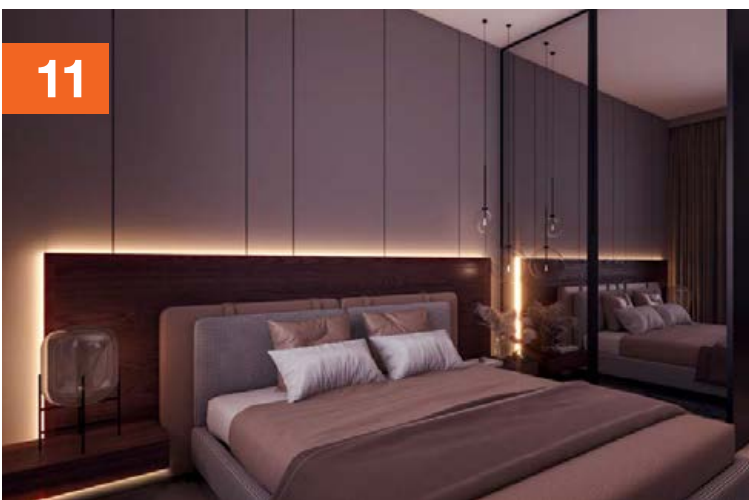

11

TAILOR-MADE PRODUCTS

SYSTEM COMPONENTS

LED STRIPS

- Protected and unprotected
- Color temperatures from 2700 to 6500 K
- Luminous flux from 500 to 2000 lm/m
- White, Tunable White, RGBW and RGB versions

COVERS

- Different versions to match the profiles
- Clear and diffuse covers

PROFILES

- 13 different versions

LED DRIVERS

- Protected and unprotected
- Dimmable and ON/OFF
- DALI-2

ACCESSORIES

- Power connectors
- Connectors
- End caps
- Mounting brackets

THE GREAT FEELING OF COPING WITH MAJOR CHALLENGES

The LEDVANCE LED Strip System contains all the components you need for your modern lighting tasks. LED Strips, profiles, covers and drivers in many different versions as well as high-quality accessories. The benefit for you is that you don't have to spend time searching for specific components and making sure that they all match. Everything comes from a single source, matches perfectly and is easy to install.

High IP rating? No problem. Dimmable light? Possible at any time with the appropriate driver or lighting management system. And for complex dynamic lighting projects you can simply add the appropriate sensors. It has never been easier to impress your customers with optimum lighting solutions.

LEDVANCE LED Strips are generally classified as containing products and have not had to carry an energy label since December 25th, 2019.

STEP BY STEP TO A CUSTOMIZED SOLUTION

LED STRIP SYSTEM CONFIGURATOR

The quick and intuitive LED Strip System Configurator* makes it extremely easy to plan any lighting project. You can use this handy online tool to define lighting requirements, mounting type, accessories, operating mode and drivers step by step. At the end, you will receive a summary with all the necessary components and useful information about mounting and installation. Of course, you can save the results of your configuration for future use. **It's easy to get started.**

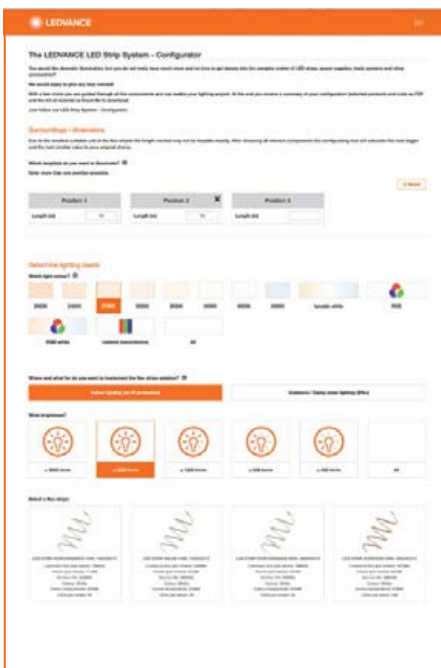

Step 1 – Lighting requirements

In addition to the length of the LED Strips, here you can also specify the light color, the area of application and the required luminous intensity.

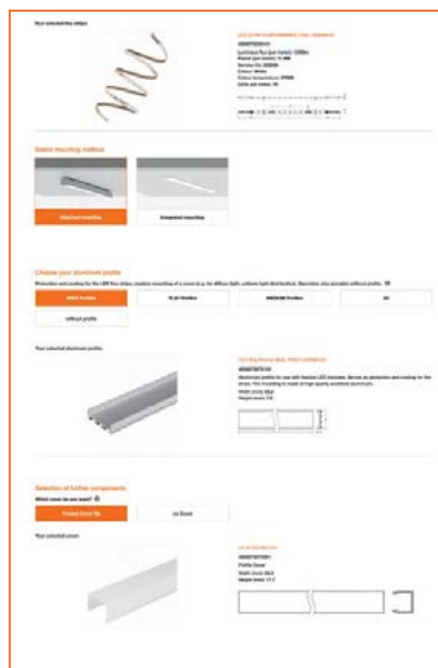

Step 2 – Mounting type

Here you can decide whether you want surface or recessed mounting, and select the right aluminum profile and cover for your project.



Step 3 – Accessories

Now you can specify all the other components: connectors, end caps and mounting accessories.

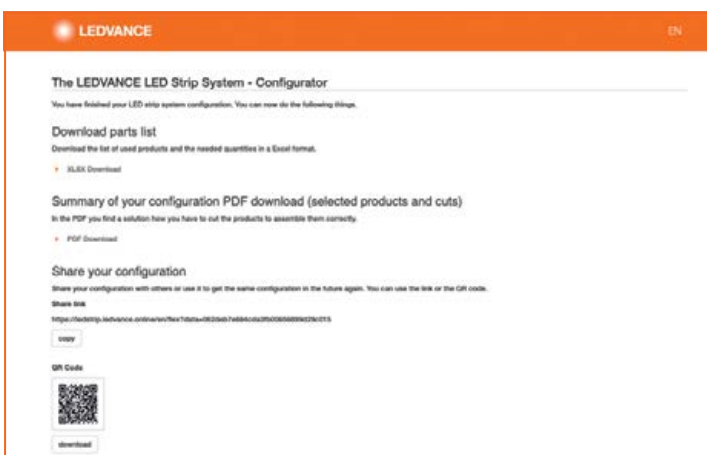

Step 4 – Operating mode

Finally, you can determine a suitable operating mode, select the right drivers and complete configuration.

Step 5 – Summary

After completing your configuration, in addition to a clear Excel parts list with all the important product information you will receive a PDF with the selected products, the cuts and a wiring diagram. You can customize the Excel sheet if needed and then send it to your wholesaler for ordering.

Visit us at
ledvance.com/led-strip-configurator



* The LED Strip System Configurator is no substitute for comprehensive professional planning with DIALux and RELUX or other professional light planning software

TIPS FOR PROFESSIONALS FOR LED STRIP INSTALLATION

THIS IS HOW THE LED STRIP SYSTEM WORKS

Tailor-made lighting solutions can be realized using LEDVANCE LED Strips. To ensure that you can professionally install the LED Strips for any project, here is some important information on the design, operation and handling of the strips – insider knowledge that will help you save time, nerves and budget and leave a professional impression on your customers.

GENERAL INFORMATION

- LEDVANCE LED Strips are easy to handle, prewired on both sides and easy to wire without any tools
- They are dimmable, and the Tunable White, RGBW and RGB strips are also suitable for dynamic colored lighting
- Easy mounting on many smooth surfaces with self-adhesive tape
- It is important to select an LED driver and/or dimmer suitable for the application
- The basic rule is as follows: the total output of the LED Strip must not exceed the maximum output of the driver



PCB (PRINTED CIRCUIT BOARD)

CURRENT CONTROL

LED

CUTTING AREA

IMPORTANT: NOTES ON HANDLING

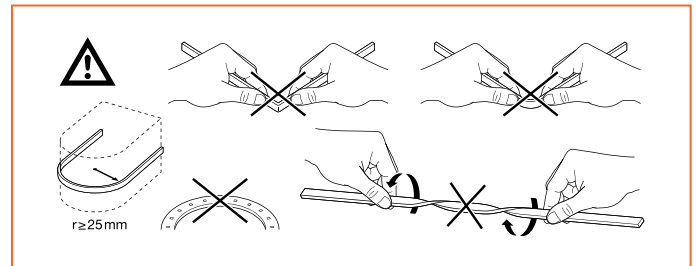

- Do not fold, bend or twist

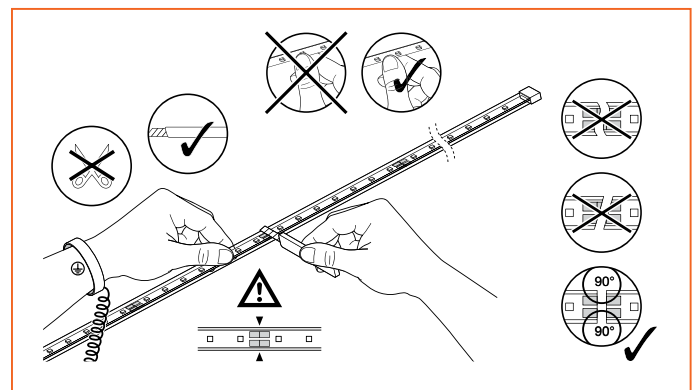

- Cut only in the designated areas
- Cut straight
- Note ESD protection
- Do not touch the LEDs on IP00 strips

Check out the LED Strip installation video at:
ledvance.com/LEDstripvideos



HOW TO WIRE LED STRIPS CORRECTLY

LEDVANCE LED Strips are easy to install. Which components you need to wire your project and how to connect them depends on whether you want to implement a static lighting solution in a white light color or a dynamic lighting solution with Tunable White, RGBW or RGB options.

EXAMPLE WIRE DIAGRAMS: STATIC VS. DYNAMIC LED STRIP SYSTEM

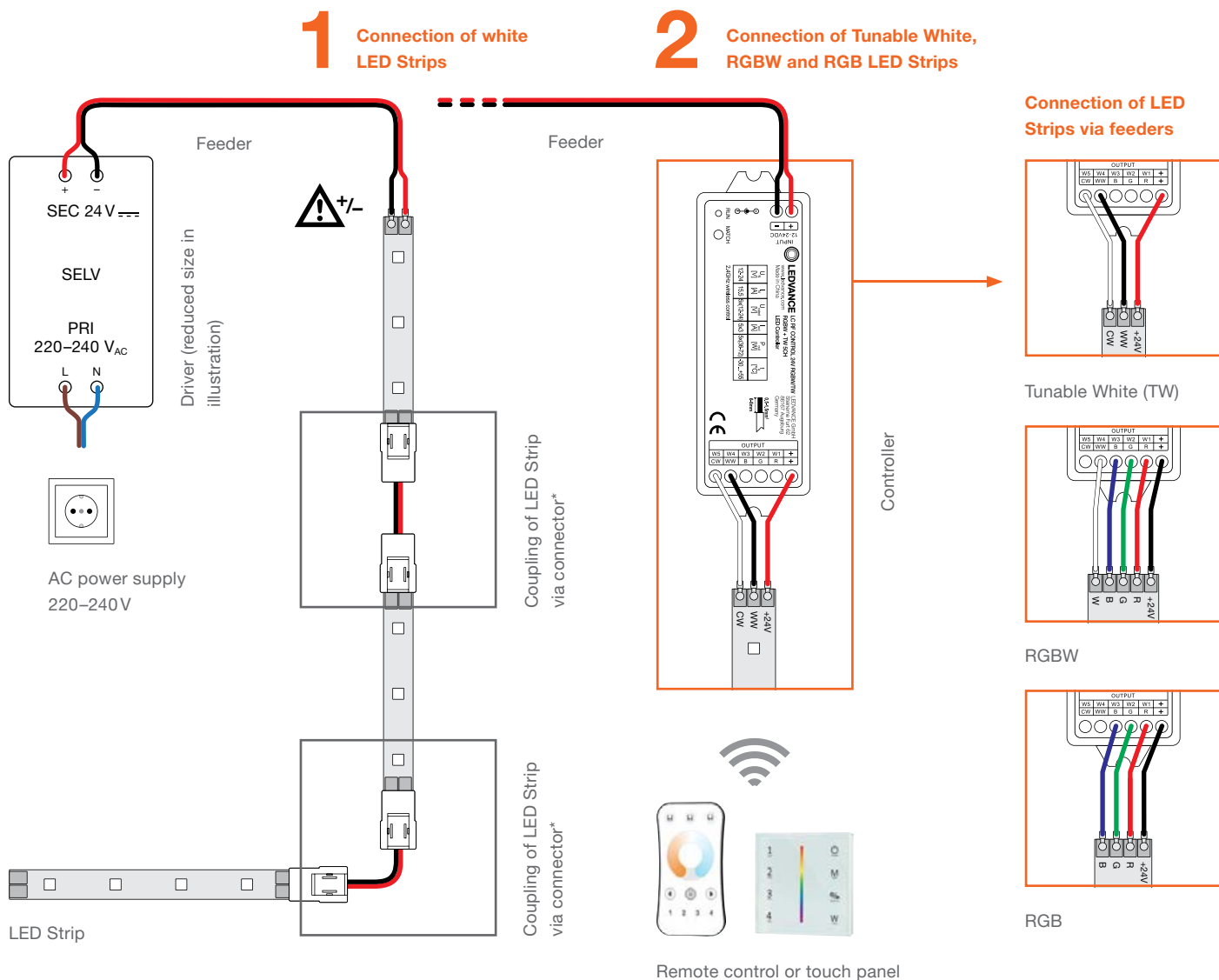

1. LED Strip System in a light color

If you are planning an LED Strip System with static white light, connect the driver to the power supply on one side and to the LED Strip on the other (+ and – respectively). To connect several LED Strips, use connectors* or a parallel connection.

2. Dynamic LED Strip System (Tunable White, RGBW, RGB)

In addition to the LED Strips and a suitable driver, you need a multichannel controller as well as a touch panel or remote control. Tunable White works with three connections (CW, WW and +), RGBW with five connections (R, G, B, W and +) and RGB with four connections (R, G, B and +).

AT A GLANCE

Are you looking for the right components for your LED Strip System? You'll see them in the compatibility overviews on pages 57, 61 and 73. Or simply visit the LED Strip Configurator at: ledvance.com/led-strip-configurator

* Note the maximum feed length, see pages 74 – 75.

WHITE – WHENEVER, WHEREVER

LED STRIPS SUPERIOR CLASS TUNABLE WHITE

TUNABLE WHITE

SUPERIOR CLASS

ACTIVATING DURING THE DAY

Cold white light with a color temperature of 6500 kelvin has an energizing effect on the human organism. This makes it ideal for all areas where people need to focus on their work. And also wherever natural daylight needs to be supplemented and enhanced by artificial light.

ATMOSPHERIC IN THE EVENING

Warm white light with a color temperature of 2700 kelvin creates a welcoming atmosphere and is ideal for all areas where you want to relax. In the evening, it allows for cozy and relaxed shopping, for example.

There are many white light colors in each Tunable White (TW) LED Strip. A controller allows users to dynamically adjust the color temperature to suit their needs, from cold-white, activating 6500 kelvin to warm-white, cozy 2700 kelvin. This not only increases the range of applications but can also contribute to personal well-being. Excellent color rendering of over CRI 90 and various types of protection for indoor and outdoor lighting (IP67) add to the options.

PRODUCT FEATURES

- Flexible and cuttable LED strip
- Smallest cuttable unit: 100 mm
- Lifetime up to 50 000 hours¹
- Color rendering index CRI > 90
- Dimmable by pulse width modulation (PWM)
- Luminous flux of up to 2 000 lm/m
- Adjustable color temperatures via Tunable White: 2 700 to 6 500 K
- Type of protection IP 00/67
- Salt mist resistant (to IEC 60068-2-52) and UV resistant (to IEC 60068-2-5) at IP67
- ENEC and TÜV approval
- 5-year guarantee²

PRODUCT BENEFITS

- Great design freedom thanks to long, flexible TW LED Strips
- Easy installation and tool-free connection
- Simple installation thanks to adhesive tape
- Maximum flexibility thanks to a wide range of accessories
- Simple connection thanks to integrated cables on both sides
- Protected LED Strips suitable for use in damp environments thanks to high degree of protection (IP67)

APPLICATIONS

- General indoor lighting
- Protected LED Strips for general outdoor lighting (IP67)
- Hotels, offices, sales and conference rooms
- Decorative cove lighting

TAKING THE SUN AS AN EXAMPLE

With Tunable White LED Strips, the spectrum of natural daylight can be simulated in its full bandwidth between 2 700 kelvin and 6 500 kelvin. This makes the strips an option for dynamic lighting which addresses people's lighting needs at certain times of the day.

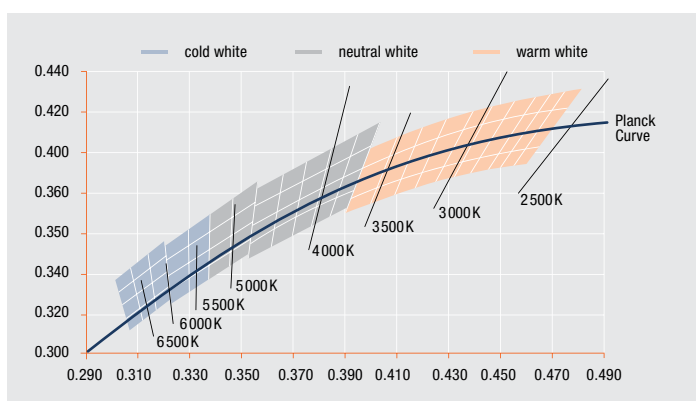

CONNECTION DIAGRAM FOR TUNABLE WHITE LED STRIP

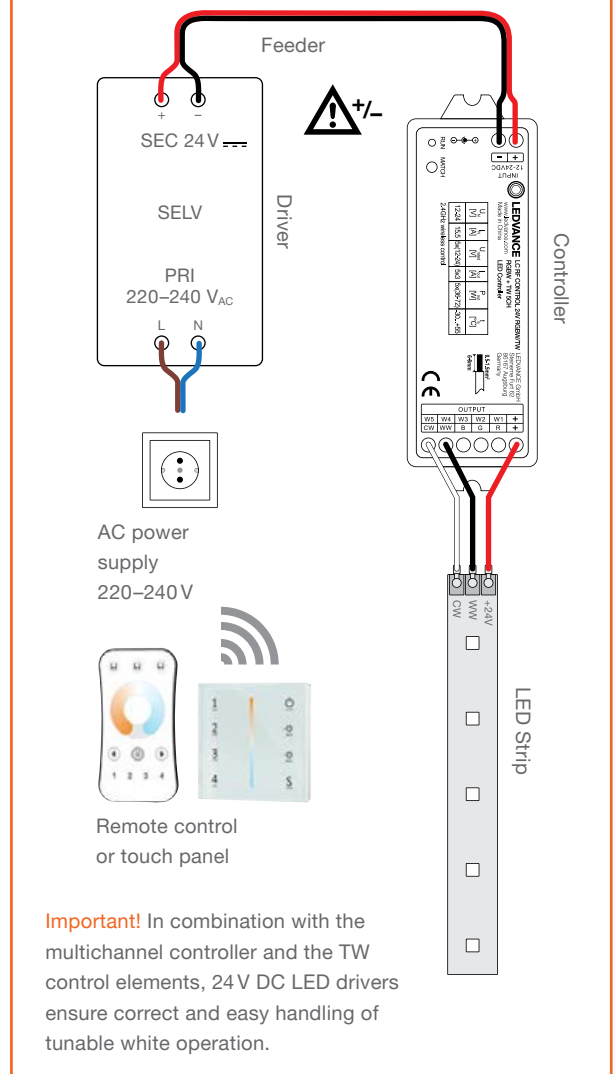

CHECK: THIS IS HOW YOUR TUNABLE WHITE LED STRIP SYSTEM WORKS



The Tunable White versions of the LEDVANCE LED Strips can be installed to suit individual planning. However, the following components are essential for a functioning Tunable White system.

System components for LEDVANCE TW LED STRIP:

Multichannel controller:
 LC RF Controller 24 V RGBW/TW
 TW control elements: remote control
 (LC RF REMOTE TW) and/or touch panel
 (LC RF TOUCH PANEL TW 220-240)

Alternatively, you can use a DALI or DMX system.

¹ L70/B50 at T_c ≤ 85 °C | ² For precise terms and conditions go to www.ledvance.com/guarantee

LED STRIP SUPERIOR-2000 TW



Tunable White LED strips with 2000 lm/m for professional applications with very good color rendering and lifetime



Prewired cables on both sides

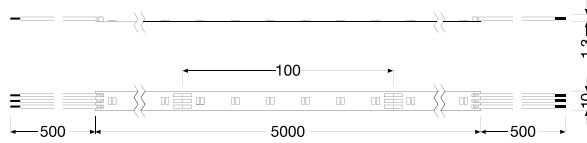

Product name	GTIN (EAN)	K	lm METER	lm	W METER	W	lm/W	⊙ METER	PITCH [mm]	Ta	L x W x H [mm]	Imax [mA]
LS SUP -2000/TW/927-965/5	4058075436084	2700...6500	950 / 1060	9140	21.6	108.0	79.0	120	16.67	-20...+55	5000x10.0x1.2	100

¹ Refer to www.ledvance.com/guarantee for precise conditions | ² Dimmable with suitable drivers, see also www.ledvance.com/dim | ³ L70/B50 at Tc max. 85 °C

STRIP ACCESSORIES

► Details see chapter STRIP ACCESSORIES

Extract from the system components of the extensive LED Strip accessories

CONNECTORS



LS AY SUP -CP/P3/500
4058075451322



LS AY SUP -CSD/P3
4058075451353



LS AY SUP -CSW/P3/50
4058075451384

ENDCAPS

MOUNTING BRACKETS



LS AY SUP -12/SMB
4058075451599

PROFILES

► Details see chapter PROFILES

Matching profiles (orange) with corresponding covers and installation accessories



LS AY -PW01/UW/
26X8/14/1
4058075278103

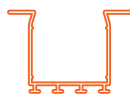

LS AY -PW02/UW/
39X26/14/1
4058075278134



LS AY -PW03/UW/
26X26/14/1
4058075278165



LS AY -PF01/UW/
22X6/10/1
4058075278196



LS AY -PF02/UW/
16X5/10/1
4058075278226



LS AY -PF03/UW/
25X7/12/1
4058075278257



LS AY -PF04/UW/
17X7/12/1
4058075278288



LS AY -PM01/UW/
21,5X12/10/1
4058075278318



LS AY -PM04/UW/
23X15,5/10/1
4058075278400



LS AY -PM05/UW/
17,5X14,5/10/1
4058075279278



LS AY -PM02/R/
18X15,5/10/1
4058075278349



LS AY -PM03/E/
19X19/10/1
4058075278370



LS AY -PM06/E/
18X18/12/1
4058075279308

DRIVERS

► Details see chapter DRIVERS

Extract from the versatile driver portfolio



DR-VAL -150/220-240/24
4058075240179



LC RF CONTROL 24V RGBW/TW
4058075435834



LC RF TOUCH PANEL TW 220-240
4058075435940



LC RF REMOTE TW
4058075435926

LED STRIP SUPERIOR-2000 TW PROTECTED



IP67 protected Tunable White LED strips with 2000 lm/m for professional applications with very good color rendering and lifetime



Prewired cables on both sides



Product name	GTIN (EAN)	K	lm METER	lm	W METER	W	lm/W	PITCH [mm]	Ta	L x W x H [mm]	Imax [mA]	
LS SUP -2000/TW/927-965/5/IP67	4058075436008	2700...6500	900 / 1010	8450	21.6	108.0	76.0	120	16.67	-20...+55	5000x12.0x5.0	100

¹ Refer to www.ledvance.com/guarantee for precise conditions | ² Dimmable with suitable drivers, see also www.ledvance.com/dim | ³ L70/B50 at Tc max. 85 °C

STRIP ACCESSORIES

► Details see chapter STRIP ACCESSORIES

Extract from the system components of the extensive LED Strip accessories

CONNECTORS



LS AY SUP -CP/P3/500/P
4058075451414



LS AY SUP -CSD/P3/P
4058075451445



LS AY SUP -CSW/P3/50/P
4058075451537

ENDCAPS



LS AY SUP -12/SE/P SIL-SEAL
4058075451568

MOUNTING BRACKETS



LS AY SUP -12/SMB
4058075451599

PROFILES

► Details see chapter PROFILES

Matching profiles (orange) with corresponding covers and installation accessories



LS AY -PW01/UW/
26X8/14/1
4058075278103



LS AY -PW02/UW/
39X26/14/1
4058075278134



LS AY -PW03/UW/
26X26/14/1
4058075278165



LS AY -PF01/UW/
22X6/10/1
4058075278196



LS AY -PF02/UW/
16X5/10/1
4058075278226



LS AY -PF03/UW/
25X7/12/1
4058075278257



LS AY -PF04/UW/
17X7/12/1
4058075278288



LS AY -PM01/UW/
21,5X12/10/1
4058075278318



LS AY -PM04/UW/
23X15,5/10/1
4058075278400



LS AY -PM05/UW/
17,5X14,5/10/1
4058075279278



LS AY -PM02/R/
18X15,5/10/1
4058075278349



LS AY -PM03/E/
19X19/10/1
4058075278370



LS AY -PM06/E/
18X18/12/1
4058075279308

DRIVERS

► Details see chapter DRIVERS

Extract from the versatile driver portfolio



DR-PFM -250/220-240/24/P
4058075240032



LC RF CONTROL 24V RGBW/TW
4058075435834



LC RF TOUCH PANEL TW 220-240
4058075435940



LC RF REMOTE TW
4058075435926

IMPRESSIVE – ALL LINE, NO DOTS

COB LED STRIPS PERFORMANCE CLASS WHITE

WHITE

PERFOR-
MANCE
CLASS

GENERAL LIGHTING

COVE LIGHTING

AMBIENT LIGHTING

With the new LEDVANCE COB LED Strips you'll no longer see the light points that are typical of conventional LED Strips. That's because there are so many LED chips that, in combination with a phosphor layer, an impressively uniform line of light is produced over their entire length. Another advantage is their high color rendering (CRI > 90). This makes them ideal for modern, exclusive lighting design, especially in the hospitality and retail sectors.



Impressively uniform lighting effect thanks to light lines without LED dots.

AMBIENT LIGHTING

For exclusive accents in modern surroundings. LEDVANCE COB LED Strips without visible LED dots work brilliantly on all glossy surfaces. Cleverly combined with cove and general lighting in different white tones, they bathe large high-ceilinged rooms in harmonious light.

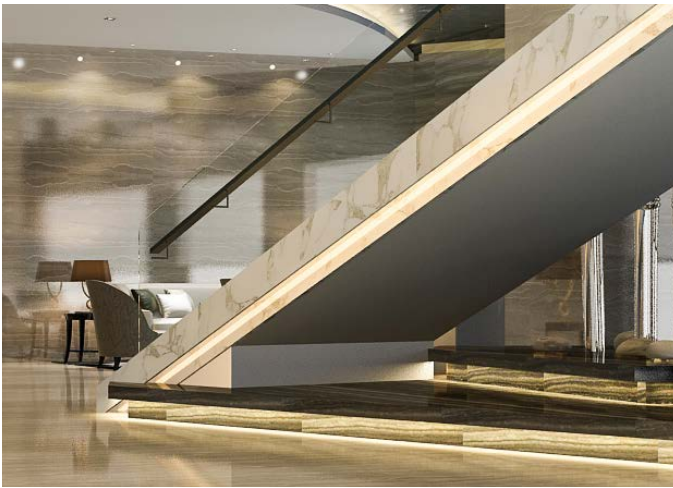

COVE LIGHTING

The continuous light lines of the COB LED Strips also show their high quality in cove lighting, making it look particularly uniform and classy.

GENERAL LIGHTING

Bringing the day inside thanks to great light quality. Especially using the cool daylight color, you can create the impression of naturally diffuse daylight with LEDVANCE COB LED Strips. The bright effect of the flexible COB strips will impress visitors and employees alike.



PRODUCT FEATURES

- Flexible and cuttable LED strip
- Luminous flux: 1 000 lm/m
- Very good color rendering index
CRI: > 90
- Smallest cuttable unit: 62.5 mm
- Large range of color temperatures:
from warm white to cool daylight
- Dimmable with suitable drivers,
see also ledvance.com/dim

PRODUCT BENEFITS

- Excellent homogenous light, without
visible light points thanks to
COB technology
- Great design freedom thanks to the
flexibility and cuttability of the module
- Easy mounting on many smooth surfaces
with self-adhesive tape on the back
- Simple connection thanks to integrated
cables on both sides
- Maximum flexibility due to a large range
of accessories
- Easy installation, no tools required for
connection

APPLICATIONS

- General illumination, cove lighting
- Bars, restaurants, hotels, shops
- Offices
- Residential interiors

LED STRIP PERFORMANCE COB -1000



High performance COB LED strip with 1000 lm/m for high requirements



Prewired cables on both sides

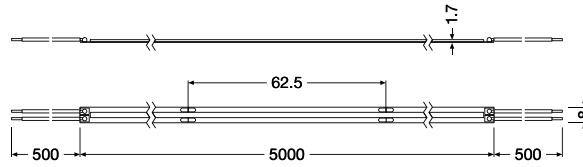

Product name	GTIN (EAN)	K	lm ⁴ METER	lm	W ⁴ METER	W	lm/W ⁴	PITCH [mm]	T _a	L x W x H [mm]	I _{max} [mA]	
LS PFM -1000/COB/927/5	4058075597525	2700	1010	2850	11.0	38.0	92.0	384	-	-20...+55	5000x8.0x1.7	62.5
LS PFM -1000/COB/930/5	4058075597532	3000	1010	3100	11.0	38.0	95.0	384	-	-20...+55	5000x8.0x1.7	62.5
LS PFM -1000/COB/940/5	4058075597549	4000	1040	3300	11.0	38.0	97.0	384	-	-20...+55	5000x8.0x1.7	62.5
LS PFM -1000/COB/965/5	4058075597556	6500	1060	3500	11.0	38.0	98.0	384	-	-20...+55	5000x8.0x1.7	62.5

¹ Refer to www.ledvance.com/guarantee for precise conditions | ² Dimmable with suitable drivers, see also www.ledvance.com/dim | ³ L70/B50 at T_c max. 65°C | ⁴ Value based on first meter of the product

STRIP ACCESSORIES

► Details see chapter STRIP ACCESSORIES

Extract from the system components of the extensive LED Strip accessories

CONNECTORS



LS AY PFM -CP-P2-500 COB
4058075654075



LS AY PFM -CSD-P2-COB
4058075654112



LS AY PFM -CSW-P2-50-COB
4058075654099

ENDCAPS

MOUNTING BRACKETS

PROFILES

► Details see chapter PROFILES

Matching profiles (orange) with corresponding covers and installation accessories



LS AY -PW01/UW/
26X8/14/1
4058075278103

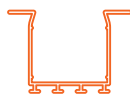

LS AY -PW02/UW/
39X26/14/1
4058075278134



LS AY -PW03/UJ/
26X26/14/1
4058075278165



LS AY -PF01/UW/
22X6/10/1
4058075278196



LS AY -PF02/UJ/
16X5/10/1
4058075278226



LS AY -PF03/UW/
25X7/12/1
4058075278257



LS AY -PF04/UJ/
17X7/12/1
4058075278288



LS AY -PM01/UW/
21,5X12/10/1
4058075278318



LS AY -PM04/UW/
23X15,5/10/1
4058075278400



LS AY -PM05/UJ/
17,5X14,5/10/1
4058075279278



LS AY -PM02/R/
18X15,5/10/1
4058075278349



LS AY -PM03/E/
19X19/10/1
4058075278370



LS AY -PM06/E/
18X18/12/1
4058075279308

DRIVERS

► Details see chapter DRIVERS

Extract from the versatile driver portfolio



DR DALI-SUP -80/220-240/24
4058075421844



DR DIM-PFM -60/220-240/24/P
4058075379190



DR VAL -60/220-240/24
4058075240094



ALLROUNDERS IN THE PROFESSIONAL LEAGUE

THE PERFORMANCE CLASS RANGE AT A GLANCE

WHITE

PERFORMANCE CLASS

GENERAL LIGHTING

COVE LIGHTING

AMBIENT LIGHTING

With the new generation of LEDVANCE Performance Class LED Strips, you have an ideal solution for professional indoor and outdoor applications. Because they boast excellent color rendering and color consistency, a great selection of color temperatures, luminous fluxes and types of protection, a lifetime up to 50 000 hours¹ and a 5-year guarantee².

Short distances between LEDs (144 LEDs/m), in conjunction with IC-controlled current, provide a very homogeneous light output over the entire strip length. The combination of high efficiency and low maintenance costs promises great potential savings. And thanks to rewiring on both sides and a well-conceived system design with drivers as well as extensive accessories including profiles, connectors and covers, installation is also quick and simple.

The Performance Class is therefore the ideal choice for professional commercial applications from offices to hospitality, indoors and outdoors.



AMBIENT LIGHTING

Creating stylish and efficient outdoor lighting could not be easier with LED Strips Performance Class. Highlighting the edges of planters with IP67 lighting strips in warm white is just one of many examples. Combined with a matching profile, LEDVANCE LED Strips Performance Class protected at 2 700 K, 500 lm/m and IP67 are ideal for atmospheric accent lighting in outdoor areas.

GENERAL LIGHTING

LED Strips Performance Class looks great even as general lighting in large open-plan offices. They provide high-intensity light, accentuating architectural features on walls and ceilings – ideally in energizing daylight white. But that's not all. LEDVANCE LED Strips Performance Class with 6 500 K, 2 000 lm/m and IP00 are suitable for the efficient illumination of workplaces and can contribute to the well-being of employees.



COVE LIGHTING

Light as a source of ideas. This room within a room is used as a think tank, with the indirect neutral white cove lighting bright enough to serve as general lighting. At the same time, it is both decorative and inspirational. All made possible by LEDVANCE LED Strips Performance Class with 4 000 K, 1 000 lm/m and IP00. Space-saving profiles and diffuse covers equipped with the appropriate LED Strips create a pleasant working atmosphere.



PRODUCT FEATURES

- Flexible, cuttable and dimmable LED strips³
- Smallest cuttable unit: 55.56 mm
- Lifetime up to 50 000 hours¹
- Very good color rendering index CRI > 90
- Color consistency SDCM < 3
- Luminous fluxes from 500 to 2 000 lm/m – tailored for ambient, cove and general lighting
- 4 color temperatures: 2 700 K, 3 000 K, 4 000 K, 6 500 K
- Type of protection IP 00/67
- Salt mist resistant (to IEC 60068-2-52) and UV resistant (to IEC 60068-2-5) at IP67
- ENEC and TÜV approval
- 5-year guarantee²

PRODUCT BENEFITS

- Great scope of design options due to long and flexible LED strips
- Easy installation, no tools required for connection
- Easy mounting on many smooth surfaces thanks to self-adhesive tape
- Protected LED Strips suitable for use in damp environments thanks to high degree of protection (IP67)
- Maximum flexibility due to large range of accessories
- Simple connection thanks to integrated cables on both sides

APPLICATIONS

- General indoor lighting
- Protected LED Strips for general outdoor lighting (IP67)
- Industry
- Offices, sales and conference rooms
- Architectural lighting
- Decorative lighting
- Decorative cove lighting

¹ L70/B50 at Tc max: 80 °C | ² For precise terms and conditions go to www.ledvance.com/guarantee | ³ Dimmable with suitable drivers, see also www.ledvance.com/dim

LED STRIP P 500

High performance LED strips with 500 lm/m for high requirements



Prewired cables on both sides

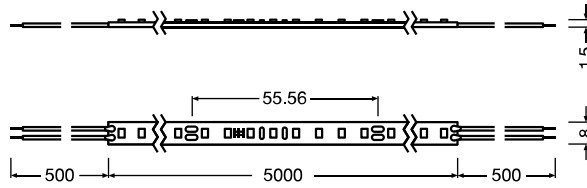

Product name	GTIN (EAN)	K	lm METER	lm	W METER	W	lm/W	⊙ METER	PITCH [mm]	Ta	L x W x H [mm]	↳ [mm]
LS P -500/927/5	4058075707474	2700	505	2265	4.2	21.0	120.0	144	6.94	-20...+55	5000x8.0x1.5	55.56
LS P -500/930/5	4058075707498	3000	515	2310	4.2	21.0	122.0	144	6.94	-20...+55	5000x8.0x1.5	55.56
LS P -500/940/5	4058075707511	4000	545	2455	4.2	21.0	130.0	144	6.94	-20...+55	5000x8.0x1.5	55.56
LS P -500/965/5	4058075707535	6500	545	2455	4.2	21.0	130.0	144	6.94	-20...+55	5000x8.0x1.5	55.56

¹ Refer to www.ledvance.com/guarantee for precise conditions | ² Dimmable with suitable drivers, see also www.ledvance.com/dim | ³ L70/B50 at Ta 55 °C

STRIP ACCESSORIES

► Details see chapter STRIP ACCESSORIES

Extract from the system components of the extensive LED Strip accessories

CONNECTORS



LS AY -CP/P2/500
4058075727403



LS AY -CSD/P2
4058075727526



LS AY -CSW/P2/50
4058075727434

ENDCAPS

MOUNTING BRACKETS



LS AY -8/SMB
4058075727588

PROFILES

► Details see chapter PROFILES

Matching profiles (orange) with corresponding covers and installation accessories



LS AY -PW01/UW/
26X8/14/1
4058075278103

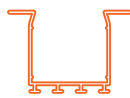

LS AY -PW02/UW/
39X26/14/1
4058075278134



LS AY -PW03/UW/
26X26/14/1
4058075278165



LS AY -PF01/UW/
22X6/10/1
4058075278196



LS AY -PF02/UW/
16X5/10/1
4058075278226



LS AY -PF03/UW/
25X7/12/1
4058075278257



LS AY -PF04/UW/
17X7/12/1
4058075278288



LS AY -PM01/UW/
21,5X12/10/1
4058075278318



LS AY -PM04/UW/
23X15,5/10/1
4058075278400



LS AY -PM05/UW/
17,5X14,5/10/1
4058075279278



LS AY -PM02/R/
18X15,5/10/1
4058075278349



LS AY -PM03/E/
19X19/10/1
4058075278370



LS AY -PM06/E/
18X18/12/1
4058075279308

DRIVERS

► Details see chapter DRIVERS

Extract from the versatile driver portfolio



DR DALI-SUP -45/220-240/24
4058075421820



DR DIM-PFM -40/220-240/24/P
4058075379176



DR VAL -30/220-240/24
4058075240056

LED STRIP P 500 P



High performance IP67 protected LED strips with 500 lm/m for high requirements



Prewired cables on both sides

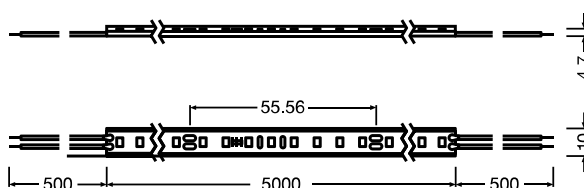

Product name	GTIN (EAN)	K	lm METER	lm	W METER	W	lm/W	IP	PITCH [mm]	Ta	L x W x H [mm]	lm/m [mm]
LS P -500/927/5/IP67	4058075705838	2700	475	2185	4.2	21.0	113.0	144	6.94	-20...+55	5000x10.0x4.7	55.56
LS P -500/930/5/IP67	4058075705852	3000	485	2220	4.2	21.0	115.0	144	6.94	-20...+55	5000x10.0x4.7	55.56
LS P -500/940/5/IP67	4058075705876	4000	515	2360	4.2	21.0	122.0	144	6.94	-20...+55	5000x10.0x4.7	55.56
LS P -500/965/5/IP67	4058075705890	6500	515	2360	4.2	21.0	122.0	144	6.94	-20...+55	5000x10.0x4.7	55.56

¹ Refer to www.ledvance.com/guarantee for precise conditions | ² Dimmable with suitable drivers, see also www.ledvance.com/dim | ³ L70/B50 at Ta 55 °C

STRIP ACCESSORIES

► Details see chapter STRIP ACCESSORIES

Extract from the system components of the extensive LED Strip accessories

CONNECTORS



LS AY -CP/P2/500/P
4058075727465



LS AY -CSD/P2/P
4058075727557



LS AY -CSW/P2/50/P
4058075727496

ENDCAPS



LS AY -10/SE/P SIL-SEAL
4058075727649

MOUNTING BRACKETS



LS AY -10/SMB
4058075727618

PROFILES

► Details see chapter PROFILES

Matching profiles (orange) with corresponding covers and installation accessories



LS AY -PW01/UW/
26X8/14/1
4058075278103



LS AY -PW02/UW/
39X26/14/1
4058075278134



LS AY -PW03/UW/
26X26/14/1
4058075278165



LS AY -PF01/UW/
22X6/10/1
4058075278196



LS AY -PF02/UW/
16X5/10/1
4058075278226



LS AY -PF03/UW/
25X7/12/1
4058075278257



LS AY -PF04/UW/
17X7/12/1
4058075278288



LS AY -PM01/UW/
21,5X12/10/1
4058075278318



LS AY -PM04/UW/
23X15,5/10/1
4058075278400



LS AY -PM05/UW/
17,5X14,5/10/1
4058075279278



LS AY -PM02/R/
18X15,5/10/1
4058075278349



LS AY -PM03/E/
19X19/10/1
4058075278370



LS AY -PM06/E/
18X18/12/1
4058075279308

DRIVERS

► Details see chapter DRIVERS

Extract from the versatile driver portfolio



DR DIM-PFM -40/220-240/24/P
4058075379176



DR-PFM -30/220-240/24/P
4058075239890



DR-VAL -30/220-240/24
4058075240056

LED STRIP P 1000



High performance LED strips with 1000 lm/m for high requirements



Prewired cables on both sides

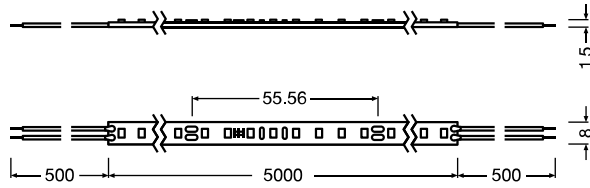

Product name	GTIN (EAN)	K	lm METER	lm	W METER	W	lm/W	⊙ METER	PITCH [mm]	Ta	L x W x H [mm]	Imax [mA]
LS P -1000/927/5	4058075707559	2700	1010	4645	8.6	43.0	118.0	144	6.94	-20...+55	5000x8.0x1.5	55.56
LS P -1000/930/5	4058075707573	3000	1030	4730	8.6	43.0	120.0	144	6.94	-20...+55	5000x8.0x1.5	55.56
LS P -1000/940/5	4058075707597	4000	1090	5030	8.6	43.0	127.0	144	6.94	-20...+55	5000x8.0x1.5	55.56
LS P -1000/965/5	4058075707610	6500	1090	5030	8.6	43.0	127.0	144	6.94	-20...+55	5000x8.0x1.5	55.56

¹ Refer to www.ledvance.com/guarantee for precise conditions | ² Dimmable with suitable drivers, see also www.ledvance.com/dim | ³ L70/B50 at Ta 55 °C

STRIP ACCESSORIES

► Details see chapter STRIP ACCESSORIES

Extract from the system components of the extensive LED Strip accessories

CONNECTORS



LS AY -CP/P2/500
405807527403



LS AY -CSD/P2
405807527526



LS AY -CSW/P2/50
405807527434

ENDCAPS

MOUNTING BRACKETS



LS AY -8/SMB
405807527588

PROFILES

► Details see chapter PROFILES

Matching profiles (orange) with corresponding covers and installation accessories



LS AY -PW01/UW/
26X8/14/1
4058075278103

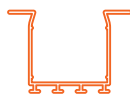

LS AY -PW02/UW/
39X26/14/1
4058075278134



LS AY -PW03/UW/
26X26/14/1
4058075278165



LS AY -PF01/UW/
22X6/10/1
4058075278196



LS AY -PF02/UW/
16X5/10/1
4058075278226



LS AY -PF03/UW/
25X7/12/1
4058075278257



LS AY -PF04/UW/
17X7/12/1
4058075278288



LS AY -PM01/UW/
21,5X12/10/1
4058075278318



LS AY -PM04/UW/
23X15,5/10/1
4058075278400



LS AY -PM05/UW/
17,5X14,5/10/1
4058075279278



LS AY -PM02/R/
18X15,5/10/1
4058075278349



LS AY -PM03/E/
19X19/10/1
4058075278370



LS AY -PM06/E/
18X18/12/1
4058075279308

DRIVERS

► Details see chapter DRIVERS

Extract from the versatile driver portfolio



DR DALI-SUP -80/220-240/24
4058075421844



DR DIM-PFM -60/220-240/24/P
4058075379190



DR VAL -60/220-240/24
4058075240094

LED STRIP P 1000 P



High performance IP67 protected LED strips with 1000 lm/m for high requirements



Prewired cables on both sides

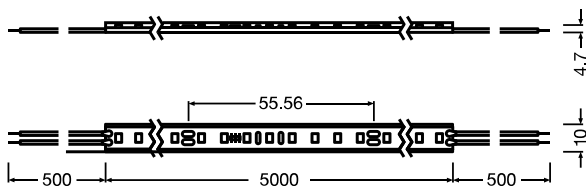

Product name	GTIN (EAN)	K	lm METER	lm	W METER	W	lm/W	⊙ METER	PITCH [mm]	Ta	L x W x H [mm]	lm/m [mm]
LS P -1000/827/5/IP66	4058075705913	2700	950	4365	8.6	43.0	110.0	144	6.94	-20...+55	5000x10.0x4.7	55.56
LS P -1000/930/5/IP67	4058075705937	3000	965	4440	8.6	43.0	112.0	144	6.94	-20...+55	5000x10.0x4.7	55.56
LS P -1000/940/5/IP67	4058075705951	4000	1030	4730	8.6	43.0	120.0	144	6.94	-20...+55	5000x10.0x4.7	55.56
LS P -1000/965/5/IP67	4058075705975	6500	1030	4730	8.6	43.0	120.0	144	6.94	-20...+55	5000x10.0x4.7	55.56

¹ Refer to www.ledvance.com/guarantee for precise conditions | ² Dimmable with suitable drivers, see also www.ledvance.com/dim | ³ L70/B50 at Ta 55 °C

STRIP ACCESSORIES

► Details see chapter STRIP ACCESSORIES

Extract from the system components of the extensive LED Strip accessories

CONNECTORS



LS AY -CP/P2/500/P
4058075727465



LS AY -CSD/P2/P
4058075727557



LS AY -CSW/P2/50/P
4058075727496

ENDCAPS



LS AY -10/SE/P SIL-SEAL
4058075727649

MOUNTING BRACKETS



LS AY -10/SMB
4058075727618

PROFILES

► Details see chapter PROFILES

Matching profiles (orange) with corresponding covers and installation accessories



LS AY -PW01/UW/
26X8/14/1
4058075278103



LS AY -PW02/UW/
39X26/14/1
4058075278134



LS AY -PW03/UW/
26X26/14/1
4058075278165



LS AY -PF01/UW/
22X6/10/1
4058075278196



LS AY -PF02/UW/
16X5/10/1
4058075278226



LS AY -PF03/UW/
25X7/12/1
4058075278257



LS AY -PF04/UW/
17X7/12/1
4058075278288



LS AY -PM01/UW/
21,5X12/10/1
4058075278318



LS AY -PM04/UW/
23X15,5/10/1
4058075278400



LS AY -PM05/UW/
17,5X14,5/10/1
4058075279278



LS AY -PM02/R/
18X15,5/10/1
4058075278349



LS AY -PM03/E/
19X19/10/1
4058075278370



LS AY -PM06/E/
18X18/12/1
4058075279308

DRIVERS

► Details see chapter DRIVERS

Extract from the versatile driver portfolio



DR DIM-PFM -60/220-240/24/P
4058075379190



DR-PFM -60/220-240/24/P
4058075239913



DR-VAL -60/220-240/24
4058075240094

LED STRIP P 1500



High performance LED strips with 1500 lm/m for high requirements



Prewired cables on both sides

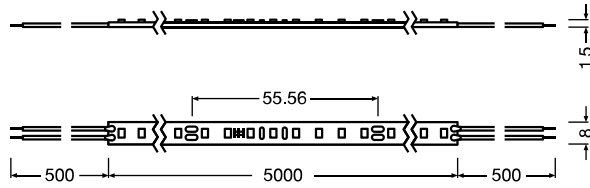

Product name	GTIN (EAN)	K	lm METER	lm	W METER	W	lm/W	IP	PITCH [mm]	Ta	L x W x H [mm]	Imax [mA]
LS P -1500/927/5	4058075707634	2700	1435	6480	12.0	60.0	119.0	144	6.94	-20...+55	5000x8.0x1.5	55.56
LS P -1500/930/5	4058075707658	3000	1455	6600	12.0	60.0	121.0	144	6.94	-20...+55	5000x8.0x1.5	55.56
LS P -1500/940/5	4058075707672	4000	1550	7020	12.0	60.0	129.0	144	6.94	-20...+55	5000x8.0x1.5	55.56
LS P -1500/965/5	4058075707696	6500	1550	7020	12.0	60.0	129.0	144	6.94	-20...+55	5000x8.0x1.5	55.56

¹ Refer to www.ledvance.com/guarantee for precise conditions | ² Dimmable with suitable drivers, see also www.ledvance.com/dim | ³ L70/B50 at Ta 55 °C

STRIP ACCESSORIES

► Details see chapter STRIP ACCESSORIES

Extract from the system components of the extensive LED Strip accessories

CONNECTORS



LS AY -CP/P2/500
4058075727403



LS AY -CSD/P2
4058075727526



LS AY -CSW/P2/50
4058075727434

ENDCAPS

MOUNTING BRACKETS



LS AY -8/SMB
4058075727588

PROFILES

► Details see chapter PROFILES

Matching profiles (orange) with corresponding covers and installation accessories



LS AY -PW01/UW/
26X8/14/1
4058075278103

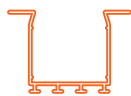

LS AY -PW02/UW/
39X26/14/1
4058075278134



LS AY -PW03/UW/
26X26/14/1
4058075278165



LS AY -PF01/UW/
22X6/10/1
4058075278196



LS AY -PF02/UW/
16X5/10/1
4058075278226



LS AY -PF03/UW/
25X7/12/1
4058075278257



LS AY -PF04/UW/
17X7/12/1
4058075278288



LS AY -PM01/UW/
21,5X12/10/1
4058075278318



LS AY -PM04/UW/
23X15,5/10/1
4058075278400



LS AY -PM05/UW/
17,5X14,5/10/1
4058075279278



LS AY -PM02/R/
18X15,5/10/1
4058075278349



LS AY -PM03/E/
19X19/10/1
4058075278370



LS AY -PM06/E/
18X18/12/1
4058075279308

DRIVERS

► Details see chapter DRIVERS

Extract from the versatile driver portfolio



DR DALI-SUP -150/220-240/24
4058075421868



DR DIM-PFM -100/220-240/24/P
4058075240070



DR VAL -120/220-240/24
4058075240131

LED STRIP P 1500 P



High performance IP67 protected LED strips with 1500 lm/m for high requirements



Prewired cables on both sides

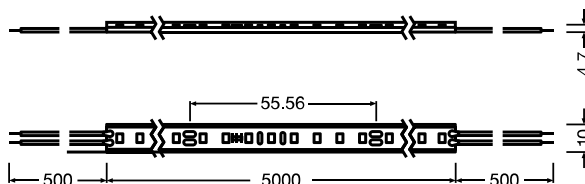

Product name	GTIN (EAN)	K	lm METER	lm	W METER	W	lm/W	① METER	PITCH [mm]	Ta	L x W x H [mm]	② lm/m [mm]
LS P -1500/927/5/IP67	4058075705999	2700	1345	6190	12.0	60.0	112.0	144	6.94	-20...+55	5000x10.0x4.7	55.56
LS P -1500/930/5/IP67	4058075706019	3000	1370	6290	12.0	60.0	114.0	144	6.94	-20...+55	5000x10.0x4.7	55.56
LS P -1500/940/5/IP67	4058075706033	4000	1460	6700	12.0	60.0	121.0	144	6.94	-20...+55	5000x10.0x4.7	55.56
LS P -1500/965/5/IP67	4058075706057	6500	1460	6700	12.0	60.0	121.0	144	6.94	-20...+55	5000x10.0x4.7	55.56

¹ Refer to www.ledvance.com/guarantee for precise conditions | ² Dimmable with suitable drivers, see also www.ledvance.com/dim | ³ L70/B50 at Ta 55 °C

STRIP ACCESSORIES

► Details see chapter STRIP ACCESSORIES

Extract from the system components of the extensive LED Strip accessories

CONNECTORS



LS AY -CP/P2/500/P
4058075727465



LS AY -CSD/P2/P
4058075727557



LS AY -CSW/P2/50/P
4058075727496

ENDCAPS



LS AY -10/SE/P SIL-SEAL
4058075727649

MOUNTING BRACKETS



LS AY -10/SMB
4058075727618

PROFILES

► Details see chapter PROFILES

Matching profiles (orange) with corresponding covers and installation accessories



LS AY -PW01/UW/
26X8/14/1
4058075278103



LS AY -PW02/UW/
39X26/14/1
4058075278134



LS AY -PW03/UW/
26X26/14/1
4058075278165



LS AY -PF01/UW/
22X6/10/1
4058075278196



LS AY -PF02/UW/
16X5/10/1
4058075278226



LS AY -PF03/UW/
25X7/12/1
4058075278257



LS AY -PF04/UW/
17X7/12/1
4058075278288



LS AY -PM01/UW/
21,5X12/10/1
4058075278318



LS AY -PM04/UW/
23X15,5/10/1
4058075278400



LS AY -PM05/UW/
17,5X14,5/10/1
4058075279278



LS AY -PM02/R/
18X15,5/10/1
4058075278349



LS AY -PM03/E/
19X19/10/1
4058075278370



LS AY -PM06/E/
18X18/12/1
4058075279308

DRIVERS

► Details see chapter DRIVERS

Extract from the versatile driver portfolio



DR DIM-PFM -100/220-240/24/P
4058075240070



DR-PFM -100/220-240/24/P
4058075239937



DR-VAL -120/220-240/24
4058075240131

LED STRIP P 2000

High performance LED strips with 2000 lm/m for high requirements



Prewired cables on both sides

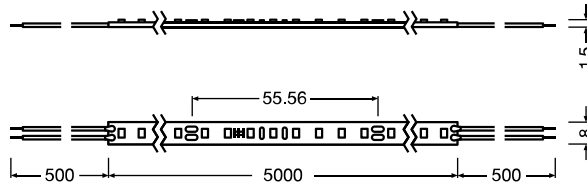

Product name	GTIN (EAN)	K	lm METER	lm	W METER	W	lm/W	⊙ METER	PITCH [mm]	Ta	L x W x H [mm]	Imax [mA]
LS P -2000/927/5	4058075707719	2700	1840	8420	15.6	78.0	118.0	144	6.94	-20...+55	5000x8.0x1.5	55.56
LS P -2000/930/5	4058075707733	3000	1870	8580	15.6	78.0	120.0	144	6.94	-20...+55	5000x8.0x1.5	55.56
LS P -2000/940/5	4058075707757	4000	1980	9125	15.6	78.0	127.0	144	6.94	-20...+55	5000x8.0x1.5	55.56
LS P -2000/965/5	4058075707771	6500	1980	9125	15.6	78.0	127.0	144	6.94	-20...+55	5000x8.0x1.5	55.56

¹ Refer to www.ledvance.com/guarantee for precise conditions | ² Dimmable with suitable drivers, see also www.ledvance.com/dim | ³ L70/B50 at Ta 55 °C

STRIP ACCESSORIES

► Details see chapter STRIP ACCESSORIES

Extract from the system components of the extensive LED Strip accessories

CONNECTORS



LS AY -CP/P2/500
4058075727403



LS AY -CSD/P2
4058075727526



LS AY -CSW/P2/50
4058075727434

ENDCAPS

MOUNTING BRACKETS



LS AY -8/SMB
4058075727588

PROFILES

► Details see chapter PROFILES

Matching profiles (orange) with corresponding covers and installation accessories



LS AY -PW01/UW/
26X8/14/1
4058075278103

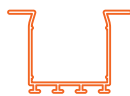

LS AY -PW02/UW/
39X26/14/1
4058075278134



LS AY -PW03/UW/
26X26/14/1
4058075278165



LS AY -PF01/UW/
22X6/10/1
4058075278196



LS AY -PF02/UW/
16X5/10/1
4058075278226



LS AY -PF03/UW/
25X7/12/1
4058075278257



LS AY -PF04/UW/
17X7/12/1
4058075278288



LS AY -PM01/UW/
21,5X12/10/1
4058075278318



LS AY -PM04/UW/
23X15,5/10/1
4058075278400



LS AY -PM05/UW/
17,5X14,5/10/1
4058075279278



LS AY -PM02/R/
18X15,5/10/1
4058075278349



LS AY -PM03/E/
19X19/10/1
4058075278370



LS AY -PM06/E/
18X18/12/1
4058075279308

DRIVERS

► Details see chapter DRIVERS

Extract from the versatile driver portfolio



DR DALI-SUP -150/220-240/24
4058075421868



DR DIM-PFM -150/220-240/24/P
4058075240117



DR VAL -150/220-240/24
4058075240179

LED STRIP P 2000 P



High performance IP67 protected LED strips with 2000 lm/m for high requirements



Prewired cables on both sides

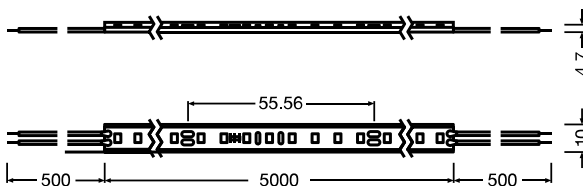

Product name	GTIN (EAN)	K	lm METER	lm	W METER	W	lm/W	IP	PITCH [mm]	Ta	L x W x H [mm]	lm/m [mm]
LS P -2000/927/5/IP67	4058075706071	2700	1725	7920	15.6	78.0	110.0	144	6.94	-20...+55	5000x10.0x4.7	55.56
LS P -2000/930/5/IP67	4058075706095	3000	1753	8050	15.6	78.0	112.0	144	6.94	-20...+55	5000x10.0x4.7	55.56
LS P -2000/940/5/IP67	4058075706118	4000	1870	8575	15.6	78.0	120.0	144	6.94	-20...+55	5000x10.0x4.7	55.56
LS P -2000/965/5/IP67	4058075706132	6500	1870	8575	15.6	78.0	120.0	144	6.94	-20...+55	5000x10.0x4.7	55.56

¹ Refer to www.ledvance.com/guarantee for precise conditions | ² Dimmable with suitable drivers, see also www.ledvance.com/dim | ³ L70/B50 at Ta 55 °C

STRIP ACCESSORIES

► Details see chapter STRIP ACCESSORIES

Extract from the system components of the extensive LED Strip accessories

CONNECTORS



LS AY -CP/P2/500/P
405807527465



LS AY -CSD/P2/P
405807527557



LS AY -CSW/P2/50/P
405807527496

ENDCAPS



LS AY -10/SE/P SIL-SEAL
405807527649

MOUNTING BRACKETS



LS AY -10/SMB
405807527618

PROFILES

► Details see chapter PROFILES

Matching profiles (orange) with corresponding covers and installation accessories



LS AY -PW01/UW/
26X8/14/1
4058075278103



LS AY -PW02/UW/
39X26/14/1
4058075278134



LS AY -PW03/UW/
26X26/14/1
4058075278165



LS AY -PF01/UW/
22X6/10/1
4058075278196



LS AY -PF02/UW/
16X5/10/1
4058075278226



LS AY -PF03/UW/
25X7/12/1
4058075278257



LS AY -PF04/UW/
17X7/12/1
4058075278288



LS AY -PM01/UW/
21,5X12/10/1
4058075278318



LS AY -PM04/UW/
23X15,5/10/1
4058075278400



LS AY -PM05/UW/
17,5X14,5/10/1
4058075279278



LS AY -PM02/R/
18X15,5/10/1
4058075278349



LS AY -PM03/E/
19X19/10/1
4058075278370



LS AY -PM06/E/
18X18/12/1
4058075279308

DRIVERS

► Details see chapter DRIVERS

Extract from the versatile driver portfolio



DR DIM-PFM -150/220-240/24/P
4058075240117



DR-PFM -150/220-240/24/P
4058075239975



DR-VAL -150/220-240/24/P
4058075240179

GOOD LIGHT AT A GOOD PRICE

THE VALUE CLASS RANGE AT A GLANCE

WHITE

VALUE
CLASS

GENERAL LIGHTING

AMBIENT LIGHTING

COVE LIGHTING

The new LEDVANCE Value Class LED Strip will help you convince your customers more than ever before. Because they combine good color rendering for general applications, a lifetime of 30 000 hours¹ and a 3-year guarantee² with low acquisition costs, good efficiency and low maintenance.

And Value Class LED Strips can also hold their own when it comes to flexibility and ease of installation – thanks to a wide range of color temperatures, luminous fluxes, types of protection, rewiring on both sides, a well-conceived system design with drivers as well as a great selection of profiles, covers and connectors.

All this makes Value Class the ideal solution in and around the home and for small commercial projects indoors and outdoors.

AMBIENT LIGHTING

The LEDVANCE Value Class proves that good light does not have to be expensive. Stylish and efficient ambient lighting on stairs is easily achieved at an excellent price/performance ratio with pleasant warm white LED Strips. LEDVANCE LED Strips Value Class with 3 000 K, 500 lm/m and IP00 are ideal for the subtle but effective illumination of staircases. Protected by a profile and with a diffuse cover they guide the way beautifully.

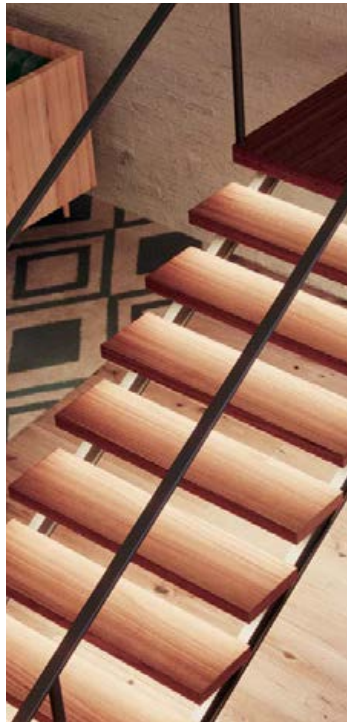

Long LED Strips Value Class in 30- or 50-meter lengths for customized solutions made to measure.

COVE LIGHTING

For kitchens, home bars or corner units in bed & breakfast establishments under-cabinet lighting with LEDVANCE LED Strips Value Class in the neutral color temperature of 4 000 K creates optimum illumination and sufficient light to work. LEDVANCE LED Strips Value Class with 4 000 K, 1 000 lm/m and IP66 can be installed near water thanks to their high IP rating. Strips can also be installed on the under-edges of counter tops to create a welcoming atmosphere.



GENERAL LIGHTING

The Value Class includes LED Strips with high luminous fluxes and daylight white 6 500 K. So you can use them in small commercial and residential areas as a cost-effective way of highlighting architectural features and creating efficient and innovative general lighting. With LEDVANCE LED Strips Value Class with 6 500 K, 2 000 lm/m and IP00 and the right profiles and covers you are ideally equipped to create perfect lighting in large rooms.

PRODUCT FEATURES

- Flexible, cuttable and dimmable LED strips³
- Smallest cuttable unit: 100 mm
- Lifetime up to 30 000 hours¹
- Color rendering index CRI > 80
- Luminous fluxes from 500 to 2 000 lm/m – tailored for ambient, cove and general lighting
- 4 color temperatures: 2 700 K, 3 000 K, 4 000 K, 6 500 K
- Type of protection IP 00/66
- Salt mist resistant (to IEC 60068-2-52) and UV resistant (to IEC 60068-2-5) at IP66
- TÜV approval
- 3-year guarantee²

PRODUCT BENEFITS

- Great scope of design options due to long and flexible LED strips
- Easy installation, no tools required for connection
- Easy mounting on many smooth surfaces thanks to self-adhesive tape
- Protected LED Strips suitable for use in damp environments thanks to high degree of protection (IP66)
- Maximum flexibility due to large range of accessories
- Simple connection thanks to integrated cables on both sides

APPLICATIONS

- General indoor lighting
- Protected LED Strips for general outdoor lighting (IP66)
- Decorative lighting
- Private living areas

¹ L70/B50 at T_c max: 75 °C | ² For precise terms and conditions go to www.ledvance.com/guarantee | ³ Dimmable with suitable drivers, see also www.ledvance.com/dim

LED STRIP V 500

LED strips with 500 lm/m for general applications



Prewired cables on both sides

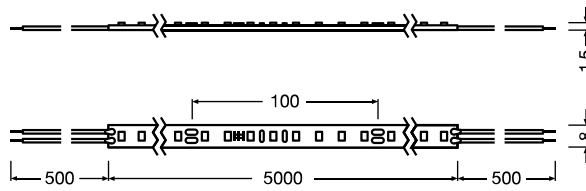

Product name	GTIN (EAN)	K	lm METER	lm	W METER	W	lm/W	PITCH [mm]	Ta	L x W x H [mm]	I _{max} [mA]	
LS V -500/827/5	4058075707795	2700	530	2330	5.0	24.0	106.0	70	14.29	-20...+55	5000x8.0x1.5	100
LS V -500/830/5	4058075707818	3000	540	2375	5.0	24.0	108.0	70	14.29	-20...+55	5000x8.0x1.5	100
LS V -500/840/5	4058075707832	4000	560	2450	5.0	24.0	112.0	70	14.29	-20...+55	5000x8.0x1.5	100
LS V -500/865/5	4058075707856	6500	560	2450	5.0	24.0	112.0	70	14.29	-20...+55	5000x8.0x1.5	100

¹ Refer to www.ledvance.com/guarantee for precise conditions | ² Dimmable with suitable drivers, see also www.ledvance.com/dim | ³ L70/B50 at Ta 55 °C | ⁴ Value based on first meter of the product

STRIP ACCESSORIES

► Details see chapter STRIP ACCESSORIES

Extract from the system components of the extensive LED Strip accessories

CONNECTORS



LS AY -CP/P2/500
4058075272403



LS AY -CSD/P2
4058075272526



LS AY -CSW/P2/50
4058075272434

ENDCAPS

MOUNTING BRACKETS



LS AY -8/SMB
4058075272588

PROFILES

► Details see chapter PROFILES

Matching profiles (orange) with corresponding covers and installation accessories



LS AY -PW01/UW/
26X8/14/1
4058075278103

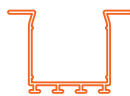

LS AY -PW02/UW/
39X26/14/1
4058075278134



LS AY -PW03/UW/
26X26/14/1
4058075278165



LS AY -PF01/UW/
22X6/10/1
4058075278196



LS AY -PF02/UW/
16X5/10/1
4058075278226



LS AY -PF03/UW/
25X7/12/1
4058075278257



LS AY -PF04/UW/
17X7/12/1
4058075278288



LS AY -PM01/UW/
21,5X12/10/1
4058075278318



LS AY -PM04/UW/
23X15,5/10/1
4058075278400



LS AY -PM05/UW/
17,5X14,5/10/1
4058075279278



LS AY -PM02/R/
18X15,5/10/1
4058075278349



LS AY -PM03/E/
19X19/10/1
4058075278370



LS AY -PM06/E/
18X18/12/1
4058075279308

DRIVERS

► Details see chapter DRIVERS

Extract from the versatile driver portfolio



DR DIM-PFM -40/220-240/24/P
4058075379176



DR-PFM -30/220-240/24/P
4058075239890



DR-VAL -30/220-240/24
4058075240056

LED STRIP V 500 P



IP66 protected LED strips with 500 lm/m for general applications



Prewired cables on both sides

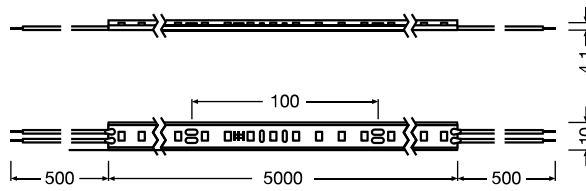

Product name	GTIN (EAN)	K	lm METER ⁴	lm	W METER ⁴	W	lm/W ⁴	PITCH [mm]	Ta	L x W x H [mm]	I _{max} [A/m]	
LS V -500/827/5/IP66	4058075705425	2700	495	2185	5.0	24.0	99.0	70	14.29	-20...+55	5000x10.0x4.1	100
LS V -500/830/5/IP66	4058075705463	3000	505	2230	5.0	24.0	101.0	70	14.29	-20...+55	5000x10.0x4.1	100
LS V -500/840/5/IP66	4058075705487	4000	525	2300	5.0	24.0	105.0	70	14.29	-20...+55	5000x10.0x4.1	100
LS V -500/865/5/IP66	4058075705500	6500	525	2300	5.0	24.0	105.0	70	14.29	-20...+55	5000x10.0x4.1	100

¹ Refer to www.ledvance.com/guarantee for precise conditions | ² Dimmable with suitable drivers, see also www.ledvance.com/dim | ³ L70/B50 at Ta 55 °C | ⁴ Value based on first meter of the product

STRIP ACCESSORIES

► Details see chapter STRIP ACCESSORIES

Extract from the system components of the extensive LED Strip accessories

CONNECTORS



LS AY -CP/P2/500/P
405807527465



LS AY -CSD/P2/P
405807527557



LS AY -CSW/P2/50/P
405807527496

ENDCAPS



LS AY -10/SE/P SIL-SEAL
405807527649

MOUNTING BRACKETS



LS AY -10/SMB
405807527618

PROFILES

► Details see chapter PROFILES

Matching profiles (orange) with corresponding covers and installation accessories



LS AY -PW01/U/
26X8/14/1
4058075278103

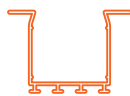

LS AY -PW02/UW/
39X26/14/1
4058075278134



LS AY -PW03/U/
26X26/14/1
4058075278165



LS AY -PF01/UW/
22X6/10/1
4058075278196



LS AY -PF02/U/
16X5/10/1
4058075278226



LS AY -PF03/UW/
25X7/12/1
4058075278257



LS AY -PF04/U/
17X7/12/1
4058075278288



LS AY -PM01/UW/
21,5X12/10/1
4058075278318



LS AY -PM04/UW/
23X15,5/10/1
4058075278400



LS AY -PM05/U/
17,5X14,5/10/1
4058075279278



LS AY -PM02/R/
18X15,5/10/1
4058075278349



LS AY -PM03/E/
19X19/10/1
4058075278370



LS AY -PM06/E/
18X18/12/1
4058075279308

DRIVERS

► Details see chapter DRIVERS

Extract from the versatile driver portfolio



DR DIM-PFM -40/220-240/24/P
4058075379176



DR-PFM -30/220-240/24/P
4058075239890



DR-VAL -30/220-240/24
4058075240056

LED STRIP V 1000

LED strips with 1000 lm/m for general applications



Prewired cables on both sides

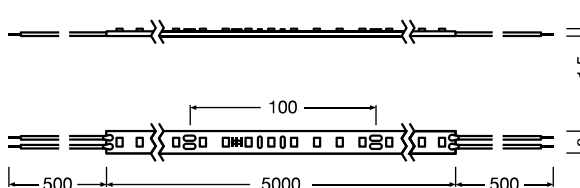

Product name	GTIN (EAN)	K	lm METER	lm	W METER	W	lm/W	PITCH [mm]	Ta	L x W x H [mm]	I _{max} [mA]	
LS V -1000/827/5	4058075707870	2700	970	3960	9.0	40.0	108.0	70	14.29	-20...+55	5000x8.0x1.5	100
LS V -1000/830/5	4058075707894	3000	1000	4040	9.0	40.0	111.0	70	14.29	-20...+55	5000x8.0x1.5	100
LS V -1000/840/5	4058075707917	4000	1040	4240	9.0	40.0	116.0	70	14.29	-20...+55	5000x8.0x1.5	100
LS V -1000/865/5	4058075707931	6500	1040	4240	9.0	40.0	116.0	70	14.29	-20...+55	5000x8.0x1.5	100

¹ Refer to www.ledvance.com/guarantee for precise conditions | ² Dimmable with suitable drivers, see also www.ledvance.com/dim | ³ L70/B50 at Ta 55 °C |

⁴ Value based on first meter of the product

STRIP ACCESSORIES

► Details see chapter STRIP ACCESSORIES

Extract from the system components of the extensive LED Strip accessories

CONNECTORS



LS AY -CP/P2/500
4058075727403



LS AY -CSD/P2
4058075727526



LS AY -CP/P2/500/P
4058075727465

ENDCAPS



LS AY -10/SE/P SIL-SEAL
4058075727649

MOUNTING BRACKETS



LS AY -8/SMB
4058075727588

PROFILES

► Details see chapter PROFILES

Matching profiles (orange) with corresponding covers and installation accessories



LS AY -PW01/UW/
26X8/14/1
4058075278103



LS AY -PW02/UW/
39X26/14/1
4058075278134



LS AY -PW03/UW/
26X26/14/1
4058075278165



LS AY -PF01/UW/
22X6/10/1
4058075278196



LS AY -PF02/UW/
16X5/10/1
4058075278226



LS AY -PF03/UW/
25X7/12/1
4058075278257



LS AY -PF04/UW/
17X7/12/1
4058075278288



LS AY -PM01/UW/
21,5X12/10/1
4058075278318



LS AY -PM04/UW/
23X15,5/10/1
4058075278400



LS AY -PM05/UW/
17,5X14,5/10/1
4058075279278



LS AY -PM02/R/
18X15,5/10/1
4058075278349



LS AY -PM03/E/
19X19/10/1
4058075278370



LS AY -PM06/E/
18X18/12/1
4058075279308

DRIVERS

► Details see chapter DRIVERS

Extract from the versatile driver portfolio



DR DIM-PFM -60/220-240/24/P
4058075379190



DR-PFM -60/220-240/24/P
4058075239913



DR-VAL -60/220-240/24
4058075240094

LED STRIP V 1000 P



IP66 protected LED strips with 1000 lm/m for general applications



Prewired cables on both sides

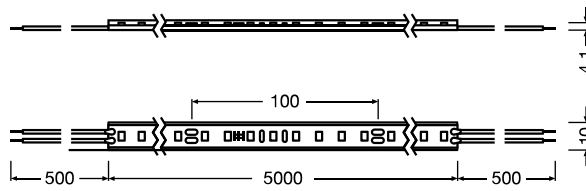

IP66 CRI >80

LEDVANCE 3 year guarantee

DIM

24V DC 120° t_h 30000 UV RESISTANT SALT MIST TUV SUD

Product name	GTIN (EAN)	K	lm METER ⁴	lm	W METER ⁴	W	lm/W ⁴	PITCH [mm]	Ta	L x W x H [mm]	I _{max} [A]	
LS V -1000/827/5/IP66	4058075705524	2700	910	3720	9.0	40.0	101.0	70	14.29	-20...+55	5000x10.0x4.1	100
LS V -1000/830/5/IP66	4058075705548	3000	935	3800	9.0	40.0	104.0	70	14.29	-20...+55	5000x10.0x4.1	100
LS V -1000/840/5/IP66	4058075705562	4000	970	3960	9.0	40.0	108.0	70	14.29	-20...+55	5000x10.0x4.1	100
LS V -1000/865/5/IP66	4058075705586	6500	970	3960	9.0	40.0	108.0	70	14.29	-20...+55	5000x10.0x4.1	100

¹ Refer to www.ledvance.com/guarantee for precise conditions | ² Dimmable with suitable drivers, see also www.ledvance.com/dim | ³ L70/B50 at Ta 55 °C | ⁴ Value based on first meter of the product

STRIP ACCESSORIES

► Details see chapter STRIP ACCESSORIES

Extract from the system components of the extensive LED Strip accessories

CONNECTORS

LS AY -CP/P2/500/P
4058075727465

LS AY -CSD/P2/P
4058075727557

LS AY -CSW/P2/50/P
4058075727496

ENDCAPS

LS AY -10/SE/P SIL-SEAL
4058075727649

MOUNTING BRACKETS

LS AY -10/SMB
4058075727618

PROFILES

► Details see chapter PROFILES

Matching profiles (orange) with corresponding covers and installation accessories

LS AY -PW01/U/
26X8/14/1
4058075278103

LS AY -PW02/UW/
39X26/14/1
4058075278134

LS AY -PW03/U/
26X26/14/1
4058075278165

LS AY -PF01/UW/
22X6/10/1
4058075278196

LS AY -PF02/U/
16X5/10/1
4058075278226

LS AY -PF03/UW/
25X7/12/1
4058075278257

LS AY -PF04/U/
17X7/12/1
4058075278288

LS AY -PM01/UW/
21,5X12/10/1
4058075278318

LS AY -PM04/UW/
23X15,5/10/1
4058075278400

LS AY -PM05/U/
17,5X14,5/10/1
4058075279278

LS AY -PM02/R/
18X15,5/10/1
4058075278349

LS AY -PM03/E/
19X19/10/1
4058075278370

LS AY -PM06/E/
18X18/12/1
4058075279308

DRIVERS

► Details see chapter DRIVERS

Extract from the versatile driver portfolio

DR DIM-PFM -60/220-240/24/P
4058075379190

DR-PFM -60/220-240/24/P
4058075239913

DR-VAL -60/220-240/24
4058075240094

LED STRIP V 1500

LED strips with 1500 lm/m for general applications



Prewired cables on both sides

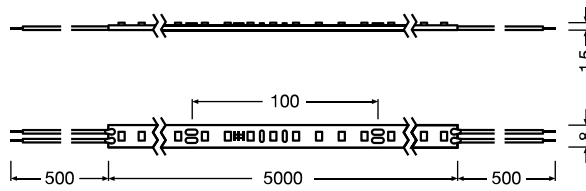

IP00 CRI >80

LEDVANCE 3 year guarantee DIM

24V DC 120° t_h 30000 TUV SUD

Product name	GTIN (EAN)	K	lm METER	lm	W METER	W	lm/W	PITCH [mm]	Ta	L x W x H [mm]	I _{max} [A/m]	
LS V -1500/827/5	4058075707955	2700	1345	5640	13.2	60.0	102.0	70	14.29	-20...+55	5000x8.0x1.5	100
LS V -1500/830/5	4058075707979	3000	1410	5880	13.2	60.0	107.0	70	14.29	-20...+55	5000x8.0x1.5	100
LS V -1500/840/5	4058075707993	4000	1490	6180	13.2	60.0	113.0	70	14.29	-20...+55	5000x8.0x1.5	100
LS V -1500/865/5	4058075708013	6500	1490	6180	13.2	60.0	113.0	70	14.29	-20...+55	5000x8.0x1.5	100

¹ Refer to www.ledvance.com/guarantee for precise conditions | ² Dimmable with suitable drivers, see also www.ledvance.com/dim | ³ L70/B50 at Ta 55 °C | ⁴ Value based on first meter of the product

STRIP ACCESSORIES

► Details see chapter STRIP ACCESSORIES

Extract from the system components of the extensive LED Strip accessories

CONNECTORS



LS AY -CP/P2/500 4058075727403
 LS AY -CSD/P2 4058075727526
 LS AY -CSW/P2/500 4058075727434

ENDCAPS

MOUNTING BRACKETS



LS AY -8/SMB 4058075727588

PROFILES

► Details see chapter PROFILES

Matching profiles (orange) with corresponding covers and installation accessories

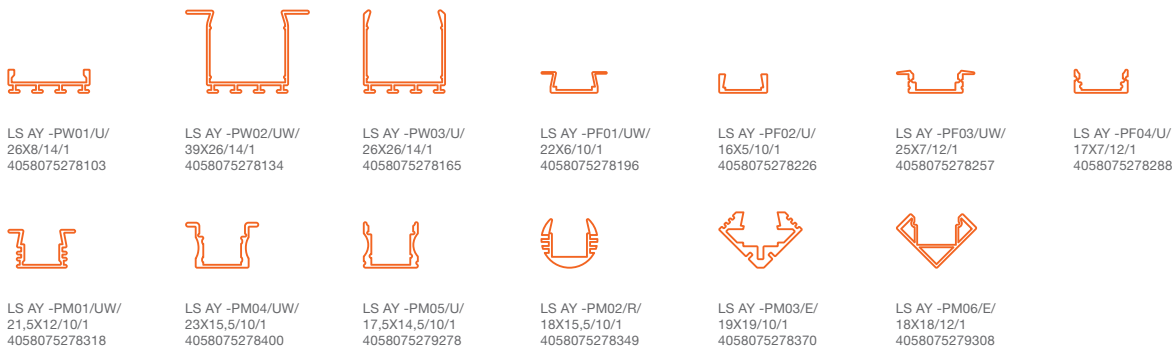

LS AY -PW01/U/ 26X8/14/1 4058075278103
 LS AY -PW02/UW/ 39X26/14/1 4058075278134
 LS AY -PW03/U/ 26X26/14/1 4058075278165
 LS AY -PF01/UW/ 22X6/10/1 4058075278196
 LS AY -PF02/U/ 16X5/10/1 4058075278226
 LS AY -PF03/UW/ 25X7/12/1 4058075278257
 LS AY -PF04/U/ 17X7/12/1 4058075278288
 LS AY -PM01/UW/ 21,5X12/10/1 4058075278318
 LS AY -PM04/UW/ 23X15,5/10/1 4058075278400
 LS AY -PM05/U/ 17,5X14,5/10/1 4058075279278
 LS AY -PM02/R/ 18X15,5/10/1 4058075278349
 LS AY -PM03/E/ 19X19/10/1 4058075278370
 LS AY -PM06/E/ 18X18/12/1 4058075279308

DRIVERS

► Details see chapter DRIVERS

Extract from the versatile driver portfolio



DR DIM-PFM -100/220-240/24/P 4058075240070
 DR-PFM -100/220-240/24/P 4058075239937
 DR-VAL -120/220-240/24 4058075240131

LED STRIP V 1500 P



IP66 protected LED strips with 1500 lm/m for general applications



Prewired cables on both sides

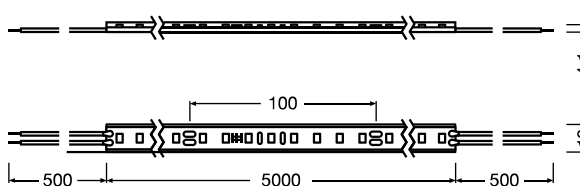

Product name	GTIN (EAN)	K	lm METER	lm	W	W	lm/W	PITCH [mm]	Ta	L x W x H [mm]	Imax [mA]	
LS V -1500/827/5/IP66	4058075705609	2700	1290	5400	13.2	60.0	98.0	70	14.29	-20...+55	5000x10.0x4.1	100
LS V -1500/830/5/IP66	4058075705623	3000	1320	5520	13.2	60.0	100.0	70	14.29	-20...+55	5000x10.0x4.1	100
LS V -1500/840/5/IP66	4058075705647	4000	1400	5820	13.2	60.0	106.0	70	14.29	-20...+55	5000x10.0x4.1	100
LS V -1500/865/5/IP66	4058075705661	6500	1400	5820	13.2	60.0	106.0	70	14.29	-20...+55	5000x10.0x4.1	100

¹ Refer to www.ledvance.com/guarantee for precise conditions | ² Dimmable with suitable drivers, see also www.ledvance.com/dim | ³ L70/B50 at Ta 55 °C | ⁴ Value based on first meter of the product

STRIP ACCESSORIES

► Details see chapter STRIP ACCESSORIES

Extract from the system components of the extensive LED Strip accessories

CONNECTORS



LS AY -CP/P2/500/P
4058075727465



LS AY -CSD/P2/P
4058075727557



LS AY -CSW/P2/50/P
4058075727496

ENDCAPS



LS AY -10/SE/P SIL-SEAL
4058075727649

MOUNTING BRACKETS



LS AY -10/SMB
4058075727618

PROFILES

► Details see chapter PROFILES

Matching profiles (orange) with corresponding covers and installation accessories



LS AY -PW01/UW/
26X8/14/1
4058075278103



LS AY -PW02/UW/
39X26/14/1
4058075278134



LS AY -PW03/UW/
26X26/14/1
4058075278165



LS AY -PF01/UW/
22X6/10/1
4058075278196



LS AY -PF02/UW/
16X5/10/1
4058075278226



LS AY -PF03/UW/
25X7/12/1
4058075278257



LS AY -PF04/UW/
17X7/12/1
4058075278288



LS AY -PM01/UW/
21,5X12/10/1
4058075278318



LS AY -PM04/UW/
23X15,5/10/1
4058075278400



LS AY -PM05/UW/
17,5X14,5/10/1
4058075279278



LS AY -PM02/R/
18X15,5/10/1
4058075278349



LS AY -PM03/E/
19X19/10/1
4058075278370



LS AY -PM06/E/
18X18/12/1
4058075279308

DRIVERS

► Details see chapter DRIVERS

Extract from the versatile driver portfolio



DR DIM-PFM -100/220-240/24/P
4058075240070



DR-PFM -100/220-240/24/P
4058075239937



DR-VAL -120/220-240/24
4058075240131



LED STRIP V 2000

LED strips with 2000 lm/m for general applications



Prewired cables on both sides

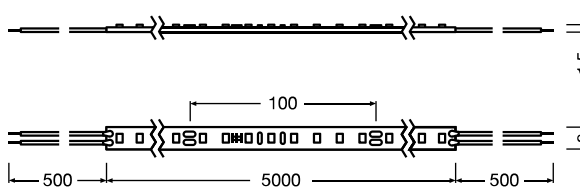

Product name	GTIN (EAN)	K	lm ⁴ METER	lm	W	W	lm/W ⁴	PITCH [mm]	Ta	L x W x H [mm]	I _{max} [mA]	
LS V -2000/827/5	4058075708037	2700	1695	6790	16.0	70.0	106.0	70	14.29	-20...+55	5000x8.0x1.5	100
LS V -2000/830/5	4058075708051	3000	1760	6850	16.0	70.0	110.0	70	14.29	-20...+55	5000x8.0x1.5	100
LS V -2000/840/5	4058075708075	4000	1820	7280	16.0	70.0	114.0	70	14.29	-20...+55	5000x8.0x1.5	100
LS V -2000/865/5	4058075708099	6500	1820	7280	16.0	70.0	114.0	70	14.29	-20...+55	5000x8.0x1.5	100

¹ Refer to www.ledvance.com/guarantee for precise conditions | ² Dimmable with suitable drivers, see also www.ledvance.com/dim | ³ L70/B50 at Ta 55 °C |

⁴ Value based on first meter of the product

STRIP ACCESSORIES

► Details see chapter STRIP ACCESSORIES

Extract from the system components of the extensive LED Strip accessories

CONNECTORS



LS AY -CP/P2/500
405807527403



LS AY -CSD/P2
405807527526



LS AY -CSW/P2/50
405807527434

ENDCAPS

MOUNTING BRACKETS



LS AY -8/SMB
405807527588

PROFILES

► Details see chapter PROFILES

Matching profiles (orange) with corresponding covers and installation accessories



LS AY -PW01/UW/
26X8/14/1
4058075278103

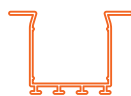

LS AY -PW02/UW/
39X26/14/1
4058075278134



LS AY -PW03/UW/
26X26/14/1
4058075278165



LS AY -PF01/UW/
22X6/10/1
4058075278196



LS AY -PF02/UW/
16X5/10/1
4058075278226



LS AY -PF03/UW/
25X7/12/1
4058075278257



LS AY -PF04/UW/
17X7/12/1
4058075278288



LS AY -PM01/UW/
21,5X12/10/1
4058075278318



LS AY -PM04/UW/
23X15,5/10/1
4058075278400



LS AY -PM05/UW/
17,5X14,5/10/1
4058075279278



LS AY -PM02/R/
18X15,5/10/1
4058075278349



LS AY -PM03/E/
19X19/10/1
4058075278370



LS AY -PM06/E/
18X18/12/1
4058075279308

DRIVERS

► Details see chapter DRIVERS

Extract from the versatile driver portfolio



DR DALI-SUP -150/220-240/24
4058075421868



DR DIM-PFM -150/220-240/24/P
4058075240117



DR VAL -150/220-240/24
4058075240179

LED STRIP V 2000 P



IP66 protected LED strips with 2000 lm/m for general applications



Prewired cables on both sides

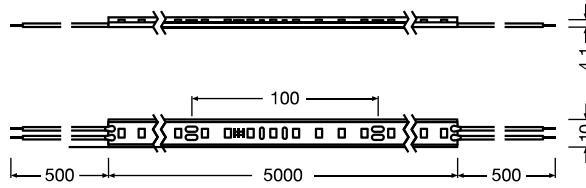

Product name	GTIN (EAN)	K	lm METER ⁴	lm	W METER ⁴	W	lm/W ⁴	PITCH [mm]	Ta	L x W x H [mm]	lm/m [mm]	
LS V -2000/827/5/IP66	4058075705685	2700	1585	6370	16.0	70.0	99.0	70	14.29	-20...+55	5000x10.0x4.1	100
LS V -2000/830/5/IP66	4058075705708	3000	1650	6580	16.0	70.0	103.0	70	14.29	-20...+55	5000x10.0x4.1	100
LS V -2000/840/5/IP66	4058075705722	4000	1710	6860	16.0	70.0	107.0	70	14.29	-20...+55	5000x10.0x4.1	100
LS V -2000/865/5/IP66	4058075705746	6500	1710	6860	16.0	70.0	107.0	70	14.29	-20...+55	5000x10.0x4.1	100

¹ Refer to www.ledvance.com/guarantee for precise conditions | ² Dimmable with suitable drivers, see also www.ledvance.com/dim | ³ L70/B50 at Ta 55 °C | ⁴ Value based on first meter of the product

STRIP ACCESSORIES

► Details see chapter STRIP ACCESSORIES

Extract from the system components of the extensive LED Strip accessories

CONNECTORS



LS AY -CP/P2/500/P
4058075727465



LS AY -CSD/P2/P
4058075727557



LS AY -CSW/P2/50/P
4058075727496

ENDCAPS



LS AY -10/SE/P SIL-SEAL
4058075727649

MOUNTING BRACKETS



LS AY -10/SMB
4058075727618

PROFILES

► Details see chapter PROFILES

Matching profiles (orange) with corresponding covers and installation accessories



LS AY -PW01/UW/
26X8/14/1
4058075278103

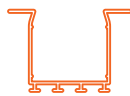

LS AY -PW02/UW/
39X26/14/1
4058075278134



LS AY -PW03/UW/
26X26/14/1
4058075278165



LS AY -PF01/UW/
22X6/10/1
4058075278196



LS AY -PF02/UW/
16X5/10/1
4058075278226



LS AY -PF03/UW/
25X7/12/1
4058075278257



LS AY -PF04/UW/
17X7/12/1
4058075278288



LS AY -PM01/UW/
21,5X12/10/1
4058075278318



LS AY -PM04/UW/
23X15,5/10/1
4058075278400



LS AY -PM05/UW/
17,5X14,5/10/1
4058075279278



LS AY -PM02/R/
18X15,5/10/1
4058075278349



LS AY -PM03/E/
19X19/10/1
4058075278370



LS AY -PM06/E/
18X18/12/1
4058075279308

DRIVERS

► Details see chapter DRIVERS

Extract from the versatile driver portfolio



DR DIM-PFM -150/220-240/24/P
4058075240117



DR-PFM -150/220-240/24/P
4058075239975



DR-VAL -150/220-240/24
4058075240179

LED STRIP VALUE-600 50 meter reel



LED strips 50m long with 600 lm/m for general applications



Prewired cables on both sides

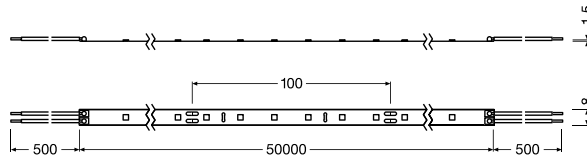

Product name	GTIN (EAN)	K	lm METER	lm	W METER	W	lm/W	PITCH [mm]	Ta	L x W x H [mm]	Imax [mA]	
LS VAL -600/830/50	4058075597402	3000	580	2620	6.1	27.5	95.0	60	16.67	-20...+40	50000x8.0x1.5	100
LS VAL -600/840/50	4058075597419	4000	600	2880	6.1	27.5	98.0	60	16.67	-20...+40	50000x8.0x1.5	100
LS VAL -600/865/50	4058075597426	6500	610	2880	6.1	27.5	100.0	60	16.67	-20...+40	50000x8.0x1.5	100

¹ Refer to www.ledvance.com/guarantee for precise conditions | ² Dimmable with suitable drivers, see also www.ledvance.com/dim | ³ L70/B50 at Tc max. 75 °C | ⁴ Value based on first meter of the product

STRIP ACCESSORIES

► Details see chapter STRIP ACCESSORIES

Extract from the system components of the extensive LED Strip accessories

CONNECTORS



LS AY -CP/P2/500
405807527403



LS AY -CSD/P2
405807527526



LS AY -CSW/P2/50
405807527434

ENDCAPS

MOUNTING BRACKETS



LS AY -8/SMB
405807527588

PROFILES

► Details see chapter PROFILES

Matching profiles (orange) with corresponding covers and installation accessories



LS AY -PW01/UW/
26X8/14/1
4058075278103

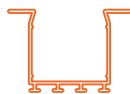

LS AY -PW02/UW/
39X26/14/1
4058075278134



LS AY -PW03/UW/
26X26/14/1
4058075278165



LS AY -PF01/UW/
22X6/10/1
4058075278196



LS AY -PF02/UW/
16X5/10/1
4058075278226



LS AY -PF03/UW/
25X7/12/1
4058075278257



LS AY -PF04/UW/
17X7/12/1
4058075278288



LS AY -PM01/UW/
21,5X12/10/1
4058075278318



LS AY -PM04/UW/
23X15,5/10/1
4058075278400



LS AY -PM05/UW/
17,5X14,5/10/1
4058075279278



LS AY -PM02/R/
18X15,5/10/1
4058075278349



LS AY -PM03/E/
19X19/10/1
4058075278370



LS AY -PM06/E/
18X18/12/1
4058075279308

DRIVERS

► Details see chapter DRIVERS

Extract from the versatile driver portfolio



DR DIM-PFM -40/220-240/24/P
4058075379176



DR-PFM -30/220-240/24/P
4058075239890



DR-VAL -30/220-240/24
4058075240056

LED STRIP VALUE-600 30 meter reel



IP65 protected LED strips 30m long with 600 lm/m for general applications



Prewired cables on both sides

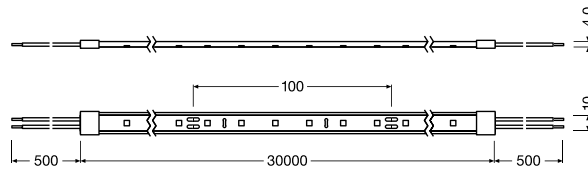

IP65 CRI > 80

LEDVANCE 3 year guarantee

DIM

24V DC

110°

t_h 20000

UV RESISTANT

Product name	GTIN (EAN)	K	lm METER ⁴	lm	W METER ⁴	W	lm/W ⁴	PITCH [mm]	T _a	L x W x H [mm]	I _{min} [mA]	
LS VAL -600/830/30/IP65	4058075597464	3000	560	2500	6.1	27.5	90.0	60	16.67	-20...+40	30000x10.0x4.0	100
LS VAL -600/840/30/IP65	4058075597471	4000	580	2740	6.1	27.5	94.0	60	16.67	-20...+40	30000x10.0x4.0	100
LS VAL -600/865/30/IP65	4058075597488	6500	580	2740	6.1	27.5	94.0	60	16.67	-20...+40	30000x10.0x4.0	100

¹ Refer to www.ledvance.com/guarantee for precise conditions | ² Dimmable with suitable drivers, see also www.ledvance.com/dim | ³ L70/B50 at T_c max. 75 °C | ⁴ Value based on first meter of the product

STRIP ACCESSORIES

► Details see chapter STRIP ACCESSORIES

Extract from the system components of the extensive LED Strip accessories

CONNECTORS



LS AY -CP/P2/500/P
405807527465



LS AY -CSD/P2/P
405807527557



LS AY -CSW/P2/50/P
405807527496

ENDCAPS



LS AY -10/SE/P SIL-SEAL
405807527649

MOUNTING BRACKETS



LS AY -10/SMB
405807527618

PROFILES

► Details see chapter PROFILES

Matching profiles (orange) with corresponding covers and installation accessories



LS AY -PW01/UW/
26X8/14/1
4058075278103

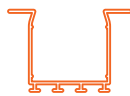

LS AY -PW02/UW/
39X26/14/1
4058075278134



LS AY -PW03/UW/
26X26/14/1
4058075278165



LS AY -PF01/UW/
22X6/10/1
4058075278196



LS AY -PF02/UW/
16X5/10/1
4058075278226



LS AY -PF03/UW/
25X7/12/1
4058075278257



LS AY -PF04/UW/
17X7/12/1
4058075278288



LS AY -PM01/UW/
21,5X12/10/1
4058075278318



LS AY -PM04/UW/
23X15,5/10/1
4058075278400



LS AY -PM05/UW/
17,5X14,5/10/1
4058075279278



LS AY -PM02/R/
18X15,5/10/1
4058075278349



LS AY -PM03/E/
19X19/10/1
4058075278370



LS AY -PM06/E/
18X18/12/1
4058075279308

DRIVERS

► Details see chapter DRIVERS

Extract from the versatile driver portfolio



DR DIM-PFM -40/220-240/24/P
4058075379176



DR-PFM -30/220-240/24/P
4058075239890



DR-VAL -30/220-240/24
4058075240056

LED STRIP VALUE-1400 50 meter reel



LED strips 50m long with 1400 lm/m for general applications



Prewired cables on both sides

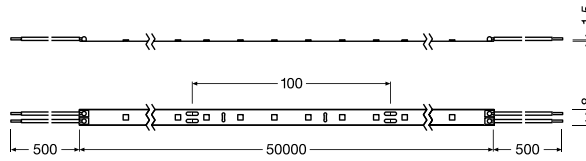

Product name	GTIN (EAN)	K	lm ⁴ METER	lm METER	W METER	W	lm/W ⁴	PITCH [mm]	T _a	L × W × H [mm]	I _{min} [mA]	
LS VAL -1400/830/50	4058075597433	3000	1370	6150	13.2	60.0	105.0	70	14.29	-20...+40	50000x8.0x1.5	100
LS VAL -1400/830/50	4058075597440	4000	1400	6280	13.2	60.0	106.0	70	14.29	-20...+40	50000x8.0x1.5	100
LS VAL -1400/865/50	4058075597457	6500	1400	6280	13.2	60.0	106.0	70	14.29	-20...+40	50000x8.0x1.5	100

¹ Refer to www.ledvance.com/guarantee for precise conditions | ² Dimmable with suitable drivers, see also www.ledvance.com/dim | ³ L70/B50 at T_c max. 75 °C | ⁴ Value based on first meter of the product

STRIP ACCESSORIES

► Details see chapter STRIP ACCESSORIES

Extract from the system components of the extensive LED Strip accessories

CONNECTORS



LS AY -CP/P2/500
405807527403



LS AY -CSD/P2
405807527526



LS AY -CSW/P2/50
405807527434

ENDCAPS

MOUNTING BRACKETS



LS AY -8/SMB
405807527588

PROFILES

► Details see chapter PROFILES

Matching profiles (orange) with corresponding covers and installation accessories



LS AY -PW01/UW/
26X8/14/1
4058075278103

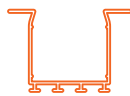

LS AY -PW02/UW/
39X26/14/1
4058075278134



LS AY -PW03/UW/
26X26/14/1
4058075278165



LS AY -PF01/UW/
22X6/10/1
4058075278196



LS AY -PF02/UW/
16X5/10/1
4058075278226



LS AY -PF03/UW/
25X7/12/1
4058075278257



LS AY -PF04/UW/
17X7/12/1
4058075278288



LS AY -PM01/UW/
21,5X12/10/1
4058075278318



LS AY -PM04/UW/
23X15,5/10/1
4058075278400



LS AY -PM05/UW/
17,5X14,5/10/1
4058075279278



LS AY -PM02/R/
18X15,5/10/1
4058075278349



LS AY -PM03/E/
19X19/10/1
4058075278370



LS AY -PM06/E/
18X18/12/1
4058075279308

DRIVERS

► Details see chapter DRIVERS

Extract from the versatile driver portfolio



DR DIM-PFM -100/220-240/24/P
4058075240070



DR-PFM -100/220-240/24/P
4058075239937



DR-VAL -120/220-240/24
4058075240131

LED STRIP VALUE-1400 30 meter reel



IP65 protected LED strips 30m long with 1400 lm/m for general applications



Prewired cables on both sides

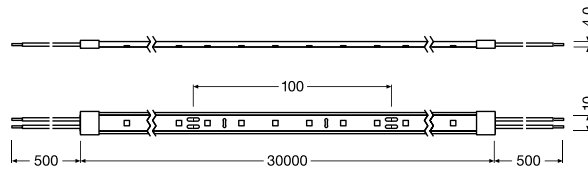

IP65 CRI >80
LEDVANCE 3 year guarantee DIM

24V DC 110° t(h) 20000 UV RESISTANT

Product name	GTIN (EAN)	K	lm METER ⁴	lm	W METER ⁴	W	lm/W ⁴	PITCH [mm]	Ta	L x W x H [mm]	I _{max} [mA]	
LS VAL -1400/830/30/IP65	4058075597495	3000	1340	5850	13.2	60.0	101.0	70	14.29	-20...+40	30000x10.0x4.0	100
LS VAL -1400/840/30/IP65	4058075597501	4000	1370	5970	13.2	60.0	104.0	70	14.29	-20...+40	30000x10.0x4.0	100
LS VAL -1400/865/30/IP65	4058075597518	6500	1370	5970	13.2	60.0	104.0	70	14.29	-20...+40	30000x10.0x4.0	100

¹ Refer to www.ledvance.com/guarantee for precise conditions | ² Dimmable with suitable drivers, see also www.ledvance.com/dim | ³ L70/B50 at Tc max. 75 °C | ⁴ Value based on first meter of the product

STRIP ACCESSORIES

► Details see chapter STRIP ACCESSORIES

Extract from the system components of the extensive LED Strip accessories

CONNECTORS



LS AY -CP/P2/500/P
4058075727465



LS AY -CSD/P2/P
4058075727557



LS AY -CSW/P2/50/P
4058075727496

ENDCAPS



LS AY -10/SE/P SIL-SEAL
4058075727649

MOUNTING BRACKETS



LS AY -10/SMB
4058075727618

PROFILES

► Details see chapter PROFILES

Matching profiles (orange) with corresponding covers and installation accessories



LS AY -PW01/UW/
26X8/14/1
4058075278103

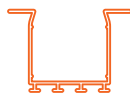

LS AY -PW02/UW/
39X26/14/1
4058075278134



LS AY -PW03/UW/
26X26/14/1
4058075278165



LS AY -PF01/UW/
22X6/10/1
4058075278196



LS AY -PF02/UW/
16X5/10/1
4058075278226



LS AY -PF03/UW/
25X7/12/1
4058075278257



LS AY -PF04/UW/
17X7/12/1
4058075278288



LS AY -PM01/UW/
21,5X12/10/1
4058075278318



LS AY -PM04/UW/
23X15,5/10/1
4058075278400



LS AY -PM05/UW/
17,5X14,5/10/1
4058075279278



LS AY -PM02/R/
18X15,5/10/1
4058075278349



LS AY -PM03/E/
19X19/10/1
4058075278370



LS AY -PM06/E/
18X18/12/1
4058075279308

DRIVERS

► Details see chapter DRIVERS

Extract from the versatile driver portfolio



DR DIM-PFM -100/220-240/24/P
4058075240070



DR-PFM -100/220-240/24/P
4058075239937



DR-VAL -120/220-240/24
4058075240131

A MIX OF WHITE AND COLOR

LED STRIPS PERFORMANCE CLASS RGBW

RGBW

PERFORMANCE CLASS

EXCITING ACCENTS

Through indirect lighting of simple objects, you can create an atmospheric ambience in rooms with RGBW LED Strips. The lighting effects can easily be adjusted to suit your needs here too – from cold-white work mode to colorful party mood.

LIGHT WITH ADDED VALUE

Whether it's white light or colored light – with RGBW LED Strips users can easily adapt the lighting to their needs. Not only do they allow for central elements in the room to be bathed in eye-catching light but also for signal effects to be generated.

LEDVANCE RGBW LED Strips are the perfect solution for all applications where you need a defined white light color in addition to RGB lighting. If you equip an application area with only one RGBW LED Strip, either a wide range of colors or a naturally white light can be controlled, depending on the requirements. RGBW LED Strips are available in four different white tones (2700, 3000, 4000 and 6500 kelvin) and also with IP66 rating for outdoor use.

PRODUCT FEATURES

- Flexible and splittable LED strip with white chip and multichip RGB LEDs
- Smallest cuttable unit: 100 mm
- Lifetime up to 40 000 hours¹
- Color rendering index CRI ≥ 80
- Dimmable by pulse width modulation (PWM)
- Luminous flux of 1 000 lm/m – tailored for ambient, cove and general lighting
- 4 white color temperatures: 2700 K, 3000 K, 4000 K, 6500 K
- Type of protection IP 00/66
- Salt mist resistant (to IEC 60068-2-52) and UV resistant (to IEC 60068-2-5) at IP66
- TÜV approval
- 3-year guarantee²

PRODUCT BENEFITS

- Great scope of design options due to long and flexible RGBW LED strips
- Easy installation, no tools required for connection
- Easy mounting thanks to self-adhesive tape
- Protected LED Strips suitable for use in damp environments thanks to high degree of protection (IP66)
- Maximum flexibility due to large range of accessories
- Simple connection thanks to integrated cables on both sides
- Intensive color effects for special moods
- Good white light quality thanks to dedicated white LEDs

APPLICATIONS

- General indoor lighting, offices, sales and conference rooms
- Protected LED Strips for general outdoor lighting (IP66)
- Dynamic effects in public zones, decorative cove lighting
- Hotels, architectural lighting and homes

HUGE COLOR SPECTRUM

In additive color mixing, red, green and blue (RGB) can reproduce a large color spectrum. Adding the white LED (RGBW) also allows for pastel tones, which significantly extends the color space.

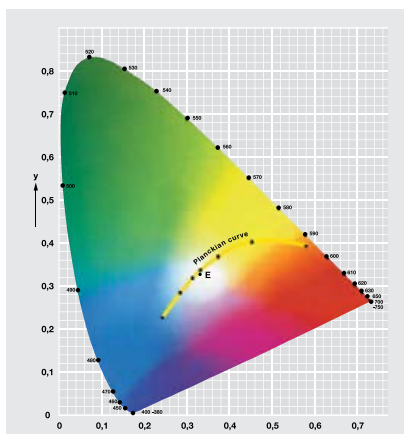

CONNECTION DIAGRAM FOR RGBW LED STRIP

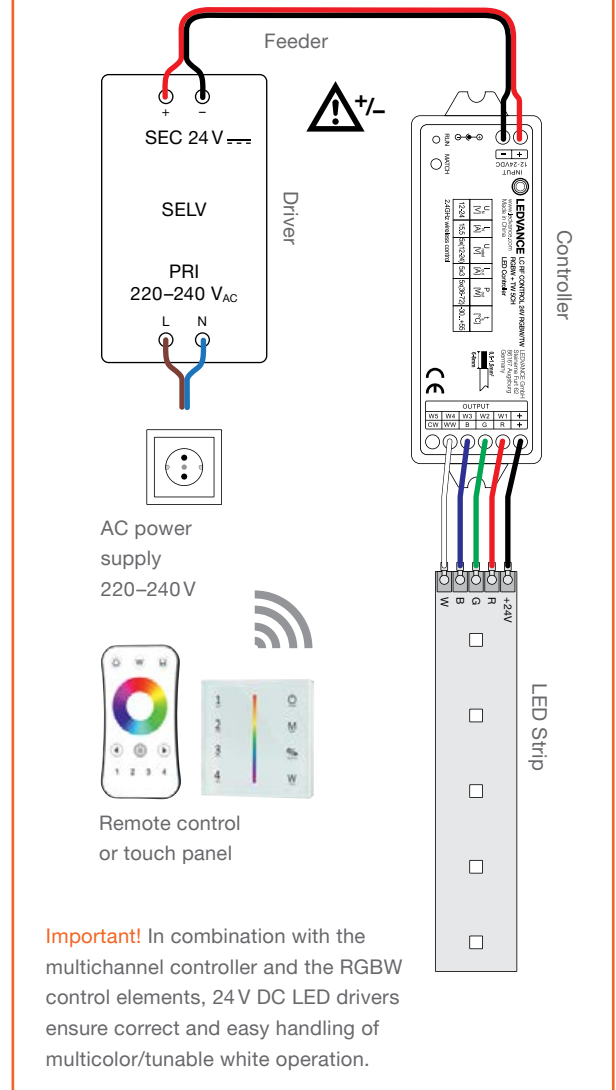

CHECK: THIS IS HOW YOUR RGBW LED STRIP SYSTEM WORKS



The RGBW versions of the LEDVANCE LED Strips can be installed to suit individual planning. However, the following components are essential for a functioning RGBW system.

- System components for LEDVANCE RGBW LED STRIP:**
- Multichannel controller RGBW/TW:
 - LC RF Controller 24 V RGBW/TW
 - Control elements RGBW: remote control (LC RF REMOTE RGBW) and/or touch panel (LC RF TOUCH PANEL RGBW 220-240)

Alternatively, you can use a DALI or DMX system.

¹ L70/B50 at Tc max. 85 °C | ² For precise terms and conditions go to www.ledvance.com/guarantee

LED STRIP PERFORMANCE-1000 RGBW



High performance RGBW LED strips with 1000 lm/m for high requirements



Prewired cables on both sides

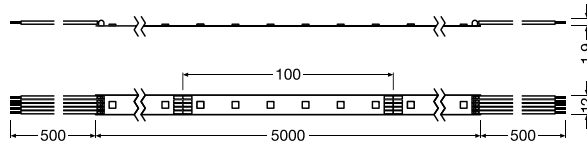

Product name	GTIN (EAN)	K	Im METER	Im	W METER	W	lm/W	PITCH [mm]	Ta	L x W x H [mm]	I _{max} [mA]	
LS PFM -1000/RGBW/827/5	4058075436145	2700	395 / R 100 / G 260 / B 65 / W 980	6335	20.0	98.0	103.0	120	16.67	-20...+55	5000x12.0x1.9	100
LS PFM -1000/RGBW/830/5	4058075436206	3000	395 / R 100 / G 260 / B 65 / W 985	6360	20.0	98.0	103.0	120	16.67	-20...+55	5000x12.0x1.9	100
LS PFM -1000/RGBW/840/5	4058075436282	4000	395 / R 100 / G 260 / B 65 / W 1045	6655	20.0	98.0	109.0	120	16.67	-20...+55	5000x12.0x1.9	100
LS PFM -1000/RGBW/865/5	4058075436312	6500	395 / R 100 / G 260 / B 65 / W 1075	6655	20.0	98.0	113.0	120	16.67	-20...+55	5000x12.0x1.9	100

¹ Refer to www.ledvance.com/guarantee for precise conditions | ² Dimmable with suitable drivers, see also www.ledvance.com/dim | ³ L70/B50 at Tc max. 85 °C

STRIP ACCESSORIES

► Details see chapter STRIP ACCESSORIES

Extract from the system components of the extensive LED Strip accessories

CONNECTORS



LS AY PFM -CP/P5/500
4058075451087



LS AY PFM -CSD/P5
4058075451117



LS AY PFM -CSW/P5/50
4058075451148

ENDCAPS

MOUNTING BRACKETS



LS AY PFM -13/SMB
4058075451292

PROFILES

► Details see chapter PROFILES

Matching profiles (orange) with corresponding covers and installation accessories



LS AY -PW01/UW/
26X8/14/1
4058075278103

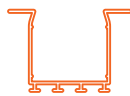

LS AY -PW02/UW/
39X26/14/1
4058075278134



LS AY -PW03/UW/
26X26/14/1
4058075278165



LS AY -PF01/UW/
22X6/10/1
4058075278196



LS AY -PF02/UW/
16X5/10/1
4058075278226



LS AY -PF03/UW/
25X7/12/1
4058075278257



LS AY -PF04/UW/
17X7/12/1
4058075278288



LS AY -PM01/UW/
21,5X12/10/1
4058075278318



LS AY -PM04/UW/
23X15,5/10/1
4058075278400



LS AY -PM05/UW/
17,5X14,5/10/1
4058075279278



LS AY -PM02/R/
18X15,5/10/1
4058075278349



LS AY -PM03/E/
19X19/10/1
4058075278370



LS AY -PM06/E/
18X18/12/1
4058075279308

DRIVERS

► Details see chapter DRIVERS

Extract from the versatile driver portfolio



DR-VAL -120/220-240/24
4058075240131



LC RF CONTROL 24V RGBW/TW
4058075435834



LC RF TOUCH PANEL RGBW 220-240
4058075435896



LC RF REMOTE RGBW
4058075435858

LED STRIP PERFORMANCE-1000 RGBW PROTECTED



High performance IP66 protected RGBW LED strips with 1000 lm/m for high requirements



Prewired cables on both sides

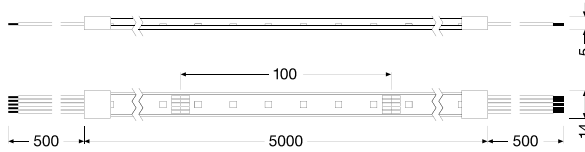

IP66 CRI > 80
SDCM < 4 DIM
LEDVANCE 3 year guarantee

RGBW 24V DC 120° t_h 40 000 UV RESISTANT SALT MIST TUV SUD

Product name	GTIN (EAN)	K	Im METER	Im	W METER	W	lm/W	PITCH [mm]	Ta	L x W x H [mm]	I _{min} [mm]	
LS PFM -1000/RGBW/827/5/IP66	4058075436053	2700	375/A 90/G 240/B 60/W 915	5725	20.0	98.0	98.0	120	16.67	-20...+55	5000x14.0x5.0	100
LS PFM -1000/RGBW/830/5/IP66	4058075436114	3000	375/A 90/G 240/B 60/W 930	5775	20.0	98.0	98.0	120	16.67	-20...+55	5000x14.0x5.0	100
LS PFM -1000/RGBW/840/5/IP66	4058075436176	4000	375/A 90/G 240/B 60/W 980	6035	20.0	98.0	103.0	120	16.67	-20...+55	5000x14.0x5.0	100
LS PFM -1000/RGBW/865/5/IP66	4058075436237	6500	375/A 90/G 240/B 60/W 990	6035	20.0	98.0	107.0	120	16.67	-20...+55	5000x14.0x5.0	100

¹ Refer to www.ledvance.com/guarantee for precise conditions | ² Dimmable with suitable drivers, see also www.ledvance.com/dim | ³ L70/B50 at Tc max. 85 °C

STRIP ACCESSORIES

► Details see chapter STRIP ACCESSORIES

Extract from the system components of the extensive LED Strip accessories

CONNECTORS



LS AY PFM -CP/P5/500/P
4058075451179



LS AY PFM -CSD/P5/P
4058075451209



LS AY PFM -CSW/P5/50/P
4058075451230

ENDCAPS



LS AY PFM -13/SE/P SIL-SEAL
4058075451261

MOUNTING BRACKETS



LS AY PFM -13/SMB
4058075451292

PROFILES

► Details see chapter PROFILES

Matching profiles (orange) with corresponding covers and installation accessories



LS AY -PW01/UW/
26X8/14/1
4058075278103

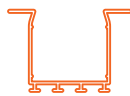

LS AY -PW02/UW/
39X26/14/1
4058075278134



LS AY -PW03/UW/
26X26/14/1
4058075278165



LS AY -PF01/UW/
22X6/10/1
4058075278196



LS AY -PF02/UW/
16X5/10/1
4058075278226



LS AY -PF03/UW/
25X7/12/1
4058075278257



LS AY -PF04/UW/
17X7/12/1
4058075278288



LS AY -PM01/UW/
21,5X12/10/1
4058075278318



LS AY -PM04/UW/
23X15,5/10/1
4058075278400



LS AY -PM05/UW/
17,5X14,5/10/1
4058075279278



LS AY -PM02/R/
18X15,5/10/1
4058075278349



LS AY -PM03/E/
19X19/10/1
4058075278370



LS AY -PM06/E/
18X18/12/1
4058075279308

DRIVERS

► Details see chapter DRIVERS

Extract from the versatile driver portfolio



DR-PFM -150/220-240/24/P
4058075239975



LC RF CONTROL 24V RGBW/TW
4058075435834



LC RF TOUCH PANEL RGBW 220-240
4058075435896



LC RF REMOTE RGBW
4058075435858

COLORFUL ACCENTS FOR A GREAT ATMOSPHERE

LED STRIPS VALUE CLASS RGB

RGB

VALUE CLASS

LIGHT TO SUIT YOUR MOOD

RGB LED Strips also allow for modern colorful ambient lighting in private areas. By means of a controller, users can add color to suit their mood and feel really comfortable.

OUTDOOR ACCENTS

Our new RGB Protected LED Strips with IP65 protection can now illuminate outdoor areas with striking colors. A multichannel controller with the relevant control unit makes it very easy to change colors.

From the primary colors red, green and blue, LEDVANCE RGB LED Strips produce a wide range of individually controllable colors with attractive saturation. In addition to reliable quality and a good price/performance ratio, high economy is ensured by simple installation and compatibility with profiles and covers. This makes RGB LED Strips ideal for providing colorful accents in and around private areas and in small commercial premises and catering facilities. A single LED Strip is often sufficient for these applications. Thanks to IP65 rating, RGB LED Strips are also suitable for outdoor use.

PRODUCT FEATURES

- Flexible and splittable LED strip with inline multichip RGB LEDs
- Smallest cuttable unit: 100 mm
- Lifetime up to 40 000 hours¹
- Color rendering index CRI ≥ 80
- Luminous flux of 500 lm/m – tailored for ambient, cove and general lighting
- Dimmable by pulse width modulation (PWM)
- Type of protection IP 00/65
- UV resistance (to IEC 60068-2-5) at IP65

PRODUCT BENEFITS

- Great scope of design options due to long and flexible RGB LED strips
- Uniform color changing
- Easy installation, no tools required for connection
- Easy mounting on many smooth surfaces thanks to self-adhesive tape
- Suitable for use in damp environments thanks to high degree of protection (IP65)
- Simple connection thanks to integrated cables on both sides

APPLICATIONS

- Suitable for indoor and outdoor use (IP65)
- Facade accent lighting
- Effect lighting in architecture
- Dynamic effects in public areas
- Cove lighting
- Under-cabinet lighting
- Hotels and offices
- Residential interiors

WIDE COLOR SPECTRUM

The three primary light colors red, green and blue allow RGB LED Strips to reproduce a wide range of colors by additive color mixing. Especially impressive is the attractive color saturation.

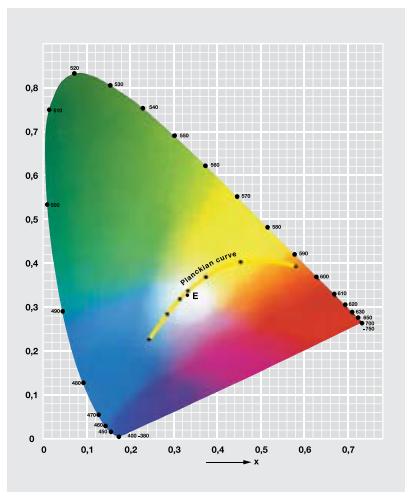

CONNECTION DIAGRAM FOR RGB LED STRIP

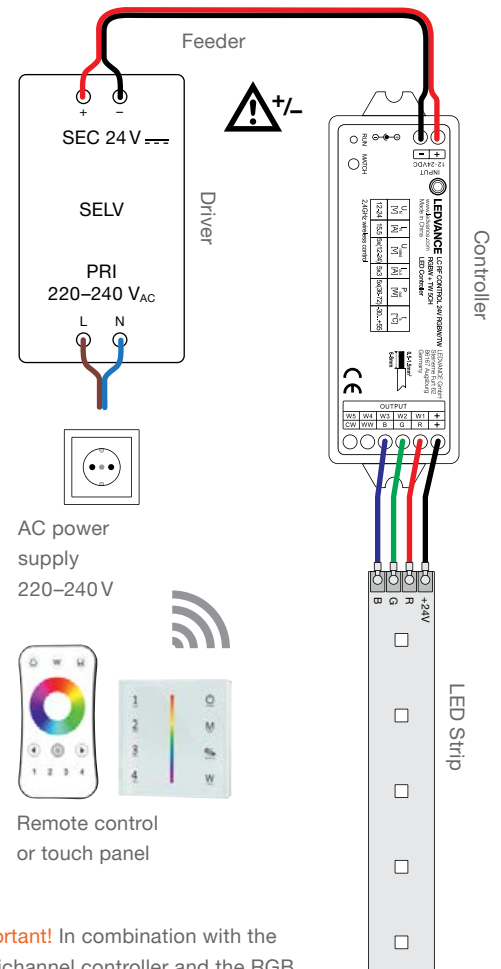

Important! In combination with the multichannel controller and the RGB control elements, 24 V DC LED drivers ensure correct and easy handling of multicolor operation.

CHECK: THIS IS HOW YOUR RGB LED STRIP SYSTEM WORKS



The RGB versions of the LEDVANCE LED Strips can be installed to suit individual planning. However, the following components are essential for a functioning RGB system.

System components for LEDVANCE RGB LED STRIP:
 Multichannel controller RGBW/TW:
 LC RF Controller 24 V RGBW/TW
 Control elements RGB: remote control
 (LC RF REMOTE RGBW) and/or touch panel
 (LC RF TOUCH PANEL RGBW 220–240)

Alternatively, you can use a DALI or DMX system.

¹ L70/B50 at T_c max. 75 °C

LED STRIP VALUE-500 RGB



RGB LED strips with 500 lm/m for general applications



Prewired cables on both sides

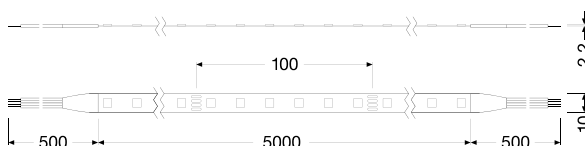

Product name	GTIN (EAN)	K	lm METER	lm	W METER	W	lm/W	METER	PITCH [mm]	Ta	L x W x H [mm]	lm/m
LS VAL -500/RGB/5	4058075404441	-	535 / R 106 / G 325 / B 73	2400	14.4	67.0	37.2	60	16.70	-20...+45	5000x10.0x2.2	100

¹ Dimmable with suitable drivers, see also www.ledvance.com/dim | ² L70/B50 at Tc max. 75 °C | ³ Value based on first meter of the product

STRIP ACCESSORIES

► Details see chapter STRIP ACCESSORIES

Extract from the system components of the extensive LED Strip accessories

CONNECTORS



LS AY VAL -CP/P4/500
4058075407800



LS AY VAL -CSD/P4
4058075407831



LS AY VAL -CSW/P4/50
4058075407862

ENDCAPS

MOUNTING BRACKETS



LS AY VAL -12/SMB
4058075411708

PROFILES

► Details see chapter PROFILES

Matching profiles (orange) with corresponding covers and installation accessories



LS AY -PW01/UW/
26X8/14/1
4058075278103



LS AY -PW02/UW/
39X26/14/1
4058075278134



LS AY -PW03/UW/
26X26/14/1
4058075278165



LS AY -PF01/UW/
22X6/10/1
4058075278196



LS AY -PF02/UW/
16X5/10/1
4058075278226



LS AY -PF03/UW/
25X7/12/1
4058075278257



LS AY -PF04/UW/
17X7/12/1
4058075278288



LS AY -PM01/UW/
21,5X12/10/1
4058075278318



LS AY -PM04/UW/
23X15,5/10/1
4058075278400



LS AY -PM05/UW/
17,5X14,5/10/1
4058075279278



LS AY -PM02/R/
18X15,5/10/1
4058075278349



LS AY -PM03/E/
19X19/10/1
4058075278370



LS AY -PM06/E/
18X18/12/1
4058075279308

DRIVERS

► Details see chapter DRIVERS

Extract from the versatile driver portfolio



DR-VAL -60/220-240/24
4058075240094



LC RF CONTROL 24V RGBW/TW
4058075435834



LC RF TOUCH PANEL RGBW 220-240
4058075435896



LC RF REMOTE RGBW
4058075435858

LED STRIP VALUE-500 RGB PROTECTED



IP65 protected RGB LED strips with 500 lm/m for general applications



Prewired cables on both sides

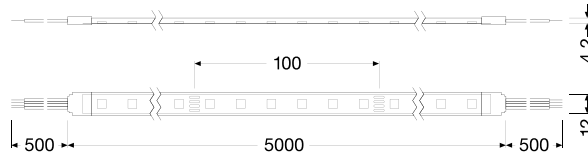

Product name	GTIN (EAN)	K	lm METER	lm	W METER	W	lm/W	PITCH [mm]	Ta	L x W x H [mm]	Imax [mA]	
LS VAL -500/RGB/5/IP65	4058075404472	-	485 / R 115 / G 355 / B 80	2150	14.4	67.0	33.7	60	16.70	-20...+45	5000x12.5x4.2	100

¹ Dimmable with suitable drivers, see also www.ledvance.com/dim | ² L70/B50 at Tc max. 75 °C | ³ Value based on first meter of the product

STRIP ACCESSORIES

► Details see chapter STRIP ACCESSORIES

Extract from the system components of the extensive LED Strip accessories

CONNECTORS



LS AY VAL -CP/P4/500/P
4058075407893



LS AY VAL -CSD/P4/P
4058075407923



LS AY VAL -CSW/P4/50/P
4058075407954

ENDCAPS



LS AY VAL -SE/P + SILICONE SEAL
4058075407985

MOUNTING BRACKETS



LS AY VAL -12/SMB
4058075411708

PROFILES

► Details see chapter PROFILES

Matching profiles (orange) with corresponding covers and installation accessories



LS AY -PW01/UW/
26X8/14/1
4058075278103

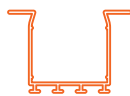

LS AY -PW02/UW/
39X26/14/1
4058075278134



LS AY -PW03/UW/
26X26/14/1
4058075278165



LS AY -PF01/UW/
22X6/10/1
4058075278196



LS AY -PF02/UW/
16X5/10/1
4058075278226



LS AY -PF03/UW/
25X7/12/1
4058075278257



LS AY -PF04/UW/
17X7/12/1
4058075278288



LS AY -PM01/UW/
21,5X12/10/1
4058075278318



LS AY -PM04/UW/
23X15,5/10/1
4058075278400



LS AY -PM05/UW/
17,5X14,5/10/1
4058075279278



LS AY -PM02/R/
18X15,5/10/1
4058075278349



LS AY -PM03/E/
19X19/10/1
4058075278370



LS AY -PM06/E/
18X18/12/1
4058075279308

DRIVERS

► Details see chapter DRIVERS

Extract from the versatile driver portfolio



DR-PFM -60/220-240/24/P
4058075239913



LC RF CONTROL 24V RGBW/TW
4058075435834



LC RF TOUCH PANEL RGBW 220-240
4058075435896



LC RF REMOTE RGBW
4058075435858

CONTROLLER, REMOTE CONTROL AND TOUCH PANEL TW/RGBW/RGB



LEDVANCE
5 year guarantee

CONTROLLER

Product name	GTIN (EAN)	Product type	V _m [VDC]	Operating frequency [GHz]	Number of channels	Max. current/channel output [A]	Max. output [W]	L x W x H [mm]	Ambient temperature T _a
LC RF CONTROL 24V RGBW/TW	4058075435834	Multichannel controller	12–24	2.4	5	5 × 3	5 × 60	114 × 38.0 × 20.0	–30...+55 °C



LEDVANCE
5 year guarantee

REMOTE CONTROL

Product name	GTIN (EAN)	Product type	V _m [VDC]	Operating frequency [GHz]	L x W x H [mm]	Ambient temperature T _a	Picture no.
LC RF REMOTE TW	4058075435926	Remote control for TW LED Strips	3 (CR2032)	2.4	107 × 58.5 × 9.0	–20...+55 °C	1
LC RF REMOTE RGBW	4058075435858	Remote control for RGBW and RGB LED Strips	3 (CR2032)	2.4	107 × 58.5 × 9.0	–20...+55 °C	2



LEDVANCE
5 year guarantee

TOUCH PANEL

Product name	GTIN (EAN)	Product type	V _m [VAC]	Operating frequency [GHz]	L x W x H [mm]	Ambient temperature T _a	Picture no.
LC RF TOUCH PANEL TW	4058075435940	Touch panel for TW LED Strips	100–240	2.4	86 × 86.0 × 33.0	–30...+55 °C	1
LC RF TOUCH PANEL RGBW	4058075435896	Touch panel for RGBW and RGB LED Strips	100–240	2.4	86 × 86.0 × 33.0	–30...+55 °C	2

HOW THE WIRING WORKS USING THE EXAMPLE OF RGBW:

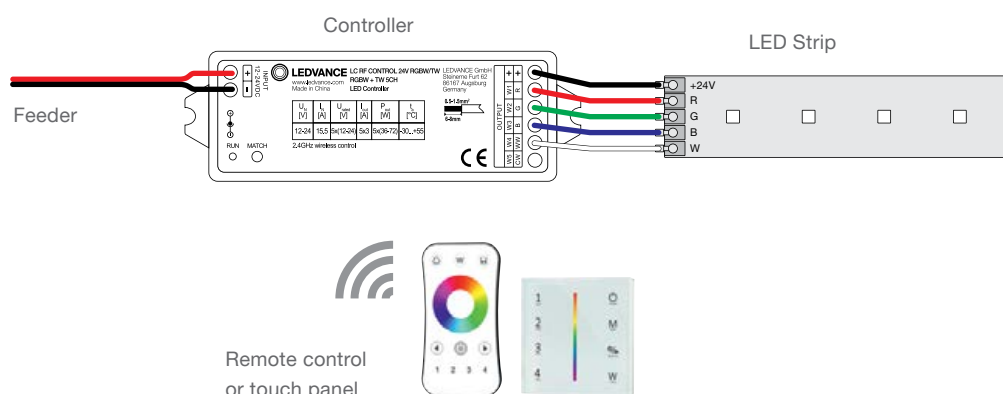

For details on the different wiring for TW/RGBW/RGB LED Strips see pages 14–15.

¹ For precise terms and conditions go to www.ledvance.com/guarantee

COMPATIBILITY OVERVIEW

FOR LED STRIPS, CONNECTORS AND ACCESSORIES

LED STRIP	CONNECTORS	ENDCAPS/MOUNTING BRACKETS
SUPERIOR CLASS TW	LS AY SUP-CP/P3/500 LS AY SUP-CSD/P3 LS AY SUP-CSW/P3/50 LS AY SUP-CP/P3/500/P LS AY SUP-CSD/P3/P LS AY SUP-CSW/P3/50/P LS AY PFM-CP/P2/500/COB LS AY PFM-CSW/P2/50/COB LS AY PFM-CSD/P2/COB LS AY -CP/P2/500 LS AY -CSD/P2 LS AY -CSW/P2/50 LS AY -CP/P2/500/P LS AY -CSD/P2/P LS AY -CSW/P2/50/P LS AY PFM-CP/P5/500 LS AY PFM-CSD/P5 LS AY PFM-CSW/P5/50 LS AY PFM-CP/P5/500/P LS AY PFM-CSD/P5/P LS AY PFM-CSW/P5/50/P LS AY VAL-CP/P4/500 LS AY VAL-CSD/P4 LS AY VAL-CSW/P4/50 LS AY VAL-CP/P4/500/P LS AY VAL-CSD/P4/P LS AY VAL-CSW/P4/50/P	ENDCAPS/MOUNTING BRACKETS LS AY PFM-13/SE/P SIL-SEAL LS AY SUP-12/SE/P SIL-SEAL LS AY -10/SE/P SIL-SEAL LS AY VAL-SE/P + SILICONE SEAL LS AY PFM-13/SMB LS AY SUP-12/SMB LS AY VAL-12/SMB LS AY-10/SMB LS AY-8/SMB
LS SUP-2000/TW	■ ■ ■	
LS SUP-2000/TW IP67	■ ■ ■	■ ■ ■
PERFORMANCE CLASS COB		
LS PFM-1000/COB	■ ■ ■	■ ■ ■
PERFORMANCE CLASS WHITE		
LS P-500	■ ■ ■	■ ■ ■
LS P-500 IP67	■ ■ ■	■ ■ ■
LS P-1000	■ ■ ■	■ ■ ■
LS P-1000 IP67	■ ■ ■	■ ■ ■
LS P-1500	■ ■ ■	■ ■ ■
LS P-1500 IP67	■ ■ ■	■ ■ ■
LS P-2000	■ ■ ■	■ ■ ■
LS P-2000 IP67	■ ■ ■	■ ■ ■
VALUE CLASS WHITE		
LS V-500	■ ■ ■	■ ■ ■
LS V-500 IP66	■ ■ ■	■ ■ ■
LS V-1000	■ ■ ■	■ ■ ■
LS V-1000 IP66	■ ■ ■	■ ■ ■
LS V-1500	■ ■ ■	■ ■ ■
LS V-1500 IP66	■ ■ ■	■ ■ ■
LS V-2000	■ ■ ■	■ ■ ■
LS V-2000 IP66	■ ■ ■	■ ■ ■
VALUE CLASS WHITE BIG REEL		
LS VAL-600/50	■ ■ ■	■ ■ ■
LS VAL-600/30/IP65	■ ■ ■	■ ■ ■
LS VAL-1400/50	■ ■ ■	■ ■ ■
LS VAL-1400/30/IP65	■ ■ ■	■ ■ ■
PERFORMANCE CLASS RGBW		
LS PFM-1000/RGBW	■ ■ ■	■ ■ ■
LS PFM-1000/RGBW IP66	■ ■ ■	■ ■ ■
VALUE CLASS RGB		

CONNECTORS, ENDCAPS, MOUNTING BRACKETS

CONNECTORS



Product name	LS AY SUP -CP/P3/500	LS AY SUP -CSD/P3	LS AY SUP -CSW/P3/50	LS AY SUP -CP/P3/500/P	LS AY SUP -CSD/P3/P
Product type	Power Connector 3-Pin with 500 mm cable	Strip Connector 3-Pin	Strip Connector 3-Pin with 50 mm cable	Power Connector 3-Pin with 500 mm cable, protected	Strip Connector 3-Pin, protected
Compatibility	Details see chapter COMPATIBILITY	Details see chapter COMPATIBILITY	Details see chapter COMPATIBILITY	Details see chapter COMPATIBILITY	Details see chapter COMPATIBILITY
GTIN (EAN)	4058075451322	4058075451353	4058075451384	4058075451414	4058075451445
L x W x H [mm]	24.3x14.6x7.7	19.6x14.6x7.7	24.3x14.6x7.7	26.0x17.0x7.2	27.0x17.0x7.2
UOP (Unit of Packaging)	2	2	2	2	2



Product name	LS AY SUP -CSW/P3/50/P	LS AY PFM -CP-P2-500 COB	LS AY PFM -CSD-P2-COB	LS AY PFM -CSW-P2-50-COB	LS AY -CP/P2/500
Product type	Strip Connector 3-Pin with 50 mm cable, protected	Power connector	Connector Strip direct	Connector Strip direct with cable	Power Connector 2-Pin with 500 mm cable
Compatibility	Details see chapter COMPATIBILITY	Details see chapter COMPATIBILITY	Details see chapter COMPATIBILITY	Details see chapter COMPATIBILITY	Details see chapter COMPATIBILITY
GTIN (EAN)	4058075451537	4058075654075	4058075654112	4058075654099	4058075727403
L x W x H [mm]	26.0x17.0x7.2	516.3x10.0x4.0	16.3x10.0x4.0	182.5x10.0x4.0	516.0x10.5x4.5
UOP (Unit of Packaging)	2	2	2	2	2



Product name	LS AY -CSD/P2	LS AY -CSW/P2/50	LS AY -CP/P2/500/P	LS AY -CSD/P2/P	LS AY -CSW/P2/50/P
Product type	Strip Connector 2-Pin	Strip Connector 2-Pin with 50 mm cable	Power Connector 2-Pin with 500 mm cable, protected	Strip Connector 2-Pin protected	Strip Connector 2-Pin with 50 mm cable, protected
Compatibility	Details see chapter COMPATIBILITY	Details see chapter COMPATIBILITY	Details see chapter COMPATIBILITY	Details see chapter COMPATIBILITY	Details see chapter COMPATIBILITY
GTIN (EAN)	4058075727526	4058075727434	4058075727465	4058075727557	4058075727496
L x W x H [mm]	20.9x10.5x4.5	82.0x10.5x4.5	526.0x15.0x7.0	27.2x15.0x7.0	102.4x15.0x7.0
UOP (Unit of Packaging)	2	2	2	2	2



Product name	LS AY PFM -CP/P5/500	LS AY PFM -CSD/P5	LS AY PFM -CSW/P5/50	LS AY PFM -CP/P5/500/P	LS AY PFM -CSD/P5/P
Product type	Power Connector 5-Pin with 500 mm cable	Strip Connector 5-Pin	Strip Connector 5-Pin with 50 mm cable	Power Connector 5-Pin with 500 mm cable, protected	Strip Connector 5-Pin, protected
Compatibility	Details see chapter COMPATIBILITY	Details see chapter COMPATIBILITY	Details see chapter COMPATIBILITY	Details see chapter COMPATIBILITY	Details see chapter COMPATIBILITY
GTIN (EAN)	4058075451087	4058075451117	4058075451148	4058075451179	4058075451209
L x W x H [mm]	24.3x17.0x7.7	19.6x17.0x7.7	24.3x17.0x7.7	26.0x19.0x7.2	27.0x19.0x7.2
UOP (Unit of Packaging)	2	2	2	2	2

CONNECTORS, ENDCAPS, MOUNTING BRACKETS

CONNECTORS



Product name	LS AY PFM -CSW/P5/50/P	LS AY VAL -CP/P4/500	LS AY VAL -CSD/P4	LS AY VAL -CSW/P4/50	LS AY VAL -CP/P4/500/P
Product type	Strip Connector 5-Pin with 50 mm cable, protected	Power Connector 4-Pin with 500 mm cable	Strip Connector 4-Pin	Strip Connector 4-Pin with 50 mm cable	Power Connector 4-Pin with 500 mm cable, protected
Compatibility	Details see chapter COMPATIBILITY				
GTIN (EAN)	4058075451230	4058075407800	4058075407831	4058075407862	4058075407893
L x W x H [mm]	26.0x19.0x7.2	515.0x14.6x7.7	19.6x14.6x7.7	98.5x14.6x7.7	516.0x17.0x7.0
UOP (Unit of Packaging)	2	2	2	2	2



Product name	LS AY VAL -CSD/P4/P	LS AY VAL -CSW/P4/50/P
Product type	Strip Connector 4-Pin, protected	Strip Connector 4-Pin with 50 mm cable, protected
Compatibility	Details see chapter COMPATIBILITY	
GTIN (EAN)	4058075407923	4058075407954
L x W x H [mm]	27.0x17.0x7.0	102.0x17.0x7.0
UOP (Unit of Packaging)	2	2

ENDCAPS



Product name	LS AY PFM -13/SE/P SIL-SEAL	LS AY SUP -12/SE/P SIL-SEAL	LS AY -10/SE/P SIL-SEAL	LS AY VAL -SE/P + SILICONE SEAL
Product type	4 Endcaps for 13 mm protected strip + 1 Silicone Seal	4 Endcaps for 12 mm protected strip + 1 Silicone Seal	4 Endcaps for 10 mm protected strip + 1 Silicone Seal	4 Endcaps for 12 mm protected strip + 1 Silicone Seal
Compatibility	Details see chapter COMPATIBILITY			
GTIN (EAN)	4058075451261	4058075451568	405807527649	4058075407985
L x W x H [mm]	15.0x10.0x6.0	13.0x10.0x6.0	12.2x5.0x10.0	14.0x10.0x6.0
UOP (Unit of Packaging)	4	4	4	4

MOUNTING BRACKETS



Product name	LS AY PFM -13/SMB	LS AY SUP -12/SMB	LS AY VAL -12/SMB	LS AY -10/SMB	LS AY -8/SMB
Product type	Mounting bracket + 2 screws for 13 mm strip	Mounting bracket + 2 screws for 12 mm strip	Mounting bracket + 2 screws for 12 mm strip	Mounting bracket + 2 screws for 10 mm strip	Mounting bracket + 2 screws for 8 mm strip
Compatibility	Details see chapter COMPATIBILITY				
GTIN (EAN)	4058075451292	4058075451599	4058075411708	4058075727618	4058075727588
L x W x H [mm]	32.0x6.0x6.0	30.0x6.0x6.0	30.0x6.0x5.5	27.5x6.0x5.2	25.5x6.0x5.2
UOP (Unit of Packaging)	2	2	2	2	2

ALL-ROUND GENIUSES

LED STRIP SYSTEM PROFILES

IMAGES FOR DIFFERENT MOUNTING VERSIONS

WIDE U-SHAPE PROFILE



Lengths available:
1 m or 2 m
Material profile:
aluminum
Cover available:
diffuse or clear
GTIN (EAN)
1 m profile:
4058075278103

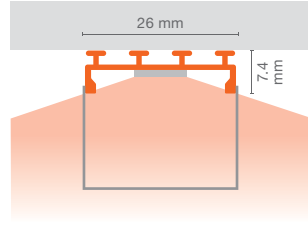

FLAT U-SHAPE WING PROFILE (12 MM WIDE)



Lengths available:
1 m or 2 m
Material profile:
aluminum
Cover available:
diffuse or clear
GTIN (EAN)
1 m profile:
4058075278257

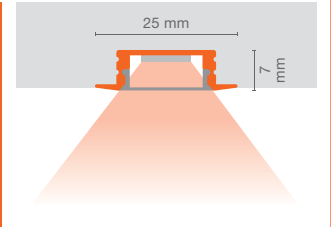

WIDE U-SHAPE WING PROFILE



Lengths available:
1 m or 2 m
Material profile:
aluminum
Cover available:
diffuse or clear
GTIN (EAN)
1 m profile:
4058075278134

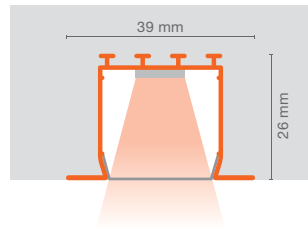

FLAT U-SHAPE PROFILE (12 MM WIDE)

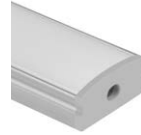

Lengths available:
1 m or 2 m
Material profile:
aluminum
Cover available:
diffuse or clear
GTIN (EAN)
1 m profile:
4058075278288

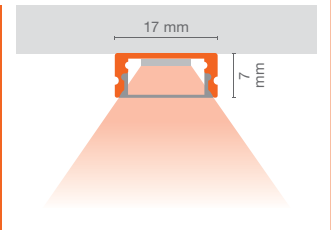

WIDE U-SHAPE PROFILE (26 MM HIGH)



Lengths available:
1 m or 2 m
Material profile:
aluminum
Cover available:
diffuse or clear
GTIN (EAN)
1 m profile:
4058075278165

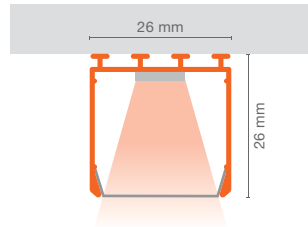

MEDIUM U-SHAPE WING PROFILE

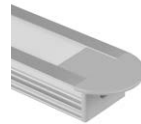

Lengths available:
1 m or 2 m
Material profile:
aluminum
Cover available:
diffuse or clear
GTIN (EAN)
1 m profile:
4058075278318

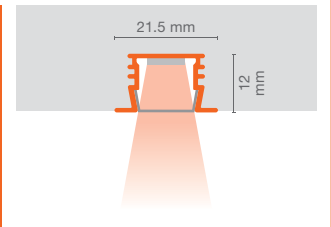

FLAT U-SHAPE WING PROFILE



Lengths available:
1 m or 2 m
Material profile:
aluminum
Cover available:
diffuse or clear
GTIN (EAN)
1 m profile:
4058075278196

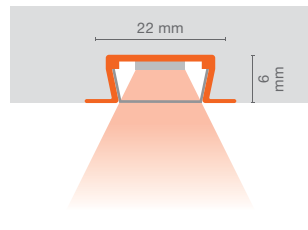

MEDIUM U-SHAPE WING PROFILE (15.5 MM HIGH)



Lengths available:
1 m or 2 m
Material profile:
aluminum
Cover available:
diffuse or clear
GTIN (EAN)
1 m profile:
4058075278400

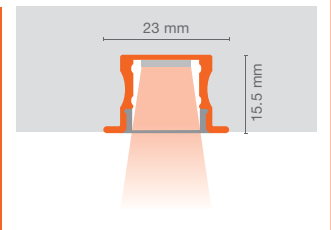

FLAT U-SHAPE PROFILE



Lengths available:
1 m or 2 m
Material profile:
aluminum
Cover available:
diffuse or clear
GTIN (EAN)
1 m profile:
4058075278226

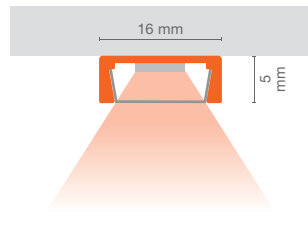

MEDIUM U-SHAPE PROFILE



Lengths available:
1 m or 2 m
Material profile:
aluminum
Cover available:
diffuse or clear
GTIN (EAN)
1 m profile:
4058075279278

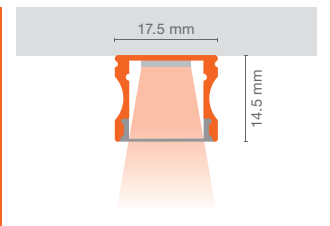

PROFILES FOR LED STRIPS

Product name	GTIN (EAN)	Product type	L x W x H [mm]		 No.
--------------	------------	--------------	----------------	---	---

Wide Profiles for LED Strips

Wide U-Shape Profile, Aluminium



LS AY -PW01/U/26X8/14/1	4058075278103	Wide U-Shape Profile, Aluminium	1000x26.0x7.4	1	1
LS AY -PW01/U/26X8/14/2	4058075401440	Wide U-Shape Profile, Aluminium, 2 m long	2000x26.0x7.4	1	1
LS AY -PC/W01/D/1	4058075279391	Wide Cover for Profile PW01 (17,7 mm high), diffuse	1000x26.3x17.7	1	2
LS AY -PC/W01/D/2	4058075401952	Wide Cover for Profile PW01 (17,7 mm high), diffuse, 2 m long	2000x26.3x17.7	1	2
LS AY -PC/W01/C/1	4058075402317	Wide Cover for Profile PW01 (17,7 mm high), clear	1000x26.3x17.7	1	-
LS AY -PC/W01/C/2	4058075402133	Wide Cover for Profile PW01 (17,7 mm high), clear, 2 m long	2000x26.3x17.7	1	-
LS AY -PW01/EC/H	4058075277366	Endcap with Hole for Profile PW01	6x26.3x23.0	2	3
LS AY -PW01/EC	4058075277335	Endcap for Profile PW01	6x26.3x23.0	2	4
LS AY -PW01/MB	4058075276611	Mounting Bracket for Profile PW01	9x26.3x7.5	2	5

Wide U-Shape Wing Profile, Aluminium

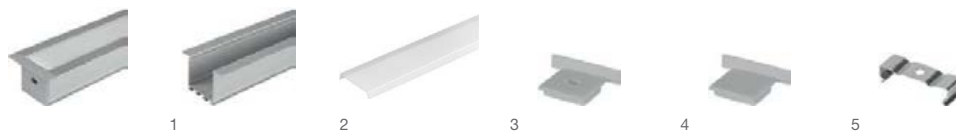
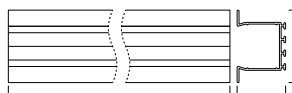

LS AY -PW02/UW/39X26/14/1	4058075278134	Wide U-Shape Wing Profile, Aluminium	1000x39.0x26.0	1	1
LS AY -PW02/UW/39X26/14/2	4058075401471	Wide U-Shape Wing Profile, Aluminium, 2 m long	2000x39.0x26.0	1	1
LS AY -PC/W02/D/1	4058075279421	Wide Cover for Profiles PW02, PW03, diffuse	1000x23.9x4.7	1	2
LS AY -PC/W02/D/2	4058075401983	Wide Cover for Profiles PW02, PW03, diffuse, 2 m long	2000x23.9x4.7	1	2
LS AY -PC/W02/C/1	4058075402348	Wide Cover for Profiles PW02, PW03, clear	1000x23.9x4.7	1	-
LS AY -PC/W02/C/2	4058075402164	Wide Cover for Profiles PW02, PW03, clear, 2 m long	2000x23.9x4.7	1	-
LS AY -PW02/EC/H	4058075277427	Endcap with Hole for Profile PW02	12x39.4x26.0	2	3
LS AY -PW02/EC	4058075277397	Endcap for Profile PW02	12x39.4x26.0	2	4
LS AY -PW02/MB	4058075276659	Mounting Bracket for Profile PW02	9x28.7x7.5	2	5

Wide U-Shape Profile (26 mm high), Aluminium



LS AY -PW03/U/26X26/14/1	4058075278165	Wide U-Shape Profile (26 mm high), Aluminium	1000x26.0x26.0	1	1
LS AY -PW03/U/26X26/14/2	4058075401501	Wide U-Shape Profile (26 mm high), Aluminium, 2 m long	2000x26.0x26.0	1	1
LS AY -PC/W02/D/1	4058075279421	Wide Cover for Profiles PW02, PW03, diffuse	1000x23.9x4.7	1	2
LS AY -PC/W02/D/2	4058075401983	Wide Cover for Profiles PW02, PW03, diffuse, 2 m long	2000x23.9x4.7	1	2
LS AY -PC/W02/C/1	4058075402348	Wide Cover for Profiles PW02, PW03, clear	1000x23.9x4.7	1	-
LS AY -PC/W02/C/2	4058075402164	Wide Cover for Profiles PW02, PW03, clear, 2 m long	2000x23.9x4.7	1	-
LS AY -PW03/EC/H	4058075277489	Endcap with Hole for Profile PW03	7.3x26.0x26.0	2	3
LS AY -PW03/EC	4058075277458	Endcap for Profile PW03	7.3x26.0x26.0	2	4
LS AY -PW03/MB	4058075276680	Mounting Bracket for Profile PW03	9x28.7x7.5	2	5

PROFILES FOR LED STRIPS

Product name	GTIN (EAN)	Product type	L x W x H [mm]		
--------------	------------	--------------	----------------	---	---

Flat Profiles for LED Strips

Flat U-Shape Wing Profile, Aluminium

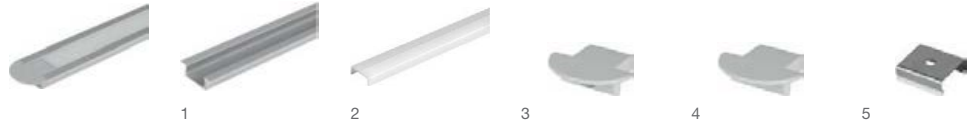
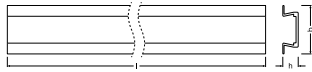

LS AY -PF01/UW/22X6/10/1	4058075278196	Flat U-Shape Wing Profile, Aluminium	1000x22.0x6.0	1	1
LS AY -PF01/UW/22X6/10/2	4058075401532	Flat U-Shape Wing Profile, Aluminium, 2 m long	2000x22.0x6.0	1	1
LS AY -PC/P02/D/1	4058075305762	Plain Cover for Profiles PF01, PM01, diffuse	1000x13.2x4.4	1	2
LS AY -PC/P02/D/2	4058075401860	Plain Cover for Profiles PF01, PM01, diffuse, 2 m long	2000x13.2x4.4	1	2
LS AY -PC/P02/C/1	4058075402225	Plain Cover for Profiles PF01, PM01, clear	1000x13.2x4.4	1	-
LS AY -PC/P02/C/2	4058075402041	Plain Cover for Profiles PF01, PM01, clear, 2 m long	2000x13.2x4.4	1	-
LS AY -PF01/EC/H	4058075277540	Endcap with Hole for Profile PF01	20.2x21.7x6.7	2	3
LS AY -PF01/EC	4058075277519	Endcap for Profile PF01	20.2x21.7x6.7	2	4
LS AY -PF01/MB	4058075276710	Mounting Bracket for Profile PF01	20x18.8x7.2	2	5

Flat U-Shape Profile, Aluminium

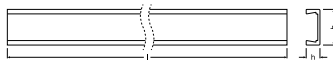

LS AY -PF02/U/16X5/10/1	4058075278226	Flat U-Shape Profile, Aluminium	1000x16.0x5.0	1	1
LS AY -PF02/U/16X5/10/2	4058075401563	Flat U-Shape Profile, Aluminium, 2 m long	2000x16.0x5.0	1	1
LS AY -PC/P01/D/1	4058075279339	Plain Cover for Profiles PF02, PM02, PM03, diffuse	1000x12.7x4.4	1	2
LS AY -PC/P01/D/2	4058075401839	Plain Cover for Profiles PF02, PM02, PM03, diffuse, 2 m long	2000x12.7x4.4	1	2
LS AY -PC/P01/C/1	4058075402195	Plain Cover for Profiles PF02, PM02, PM03, clear	1000x12.7x4.4	1	-
LS AY -PC/P01/C/2	4058075402010	Plain Cover for Profiles PF02, PM02, PM03, clear, 2 m long	2000x12.7x4.4	1	-
LS AY -PF02/EC/H	4058075277601	Endcap with Hole for Profile PF02	11.5x15.5x5.8	2	3
LS AY -PF02/EC	4058075277571	Endcap for Profile PF02	11.5x15.5x5.8	2	4
LS AY -PF02/MB	4058075276741	Mounting Bracket for Profile PF02	20x18.8x7.2	2	5

Flat U-Shape Wing Profile (12 mm wide), Aluminium

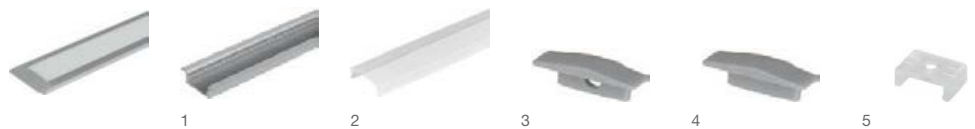

LS AY -PF03/UW/25X7/12/1	4058075278257	Flat U-Shape Wing Profile (12 mm wide), Aluminium	1000x25.0x7.0	1	1
LS AY -PF03/UW/25X7/12/2	4058075401594	Flat U-Shape Wing Profile (12 mm wide), Aluminium, 2 m long	2000x25.0x7.0	1	1
LS AY -PC/R01/D/1	4058075279360	Round Cover for Profiles PM05, PM06, PF03, PF04, diffuse	1000x15.2x4.7	1	2
LS AY -PC/R01/D/2	4058075401891	Round Cover for Profiles PM05, PM06, PF03, PF04, diffuse, 2 m long	2000x15.2x4.7	1	2
LS AY -PC/R01/C/1	4058075402256	Round Cover for Profiles PM05, PM06, PF03, PF04, clear	1000x15.2x4.7	1	-
LS AY -PC/R01/C/2	4058075402072	Round Cover for Profiles PM05, PM06, PF03, PF04, clear, 2 m long	2000x15.2x4.7	1	-
LS AY -PF03/EC/H	4058075277663	Endcap with Hole for Profile PF03	7.8x25.0x8.3	2	3
LS AY -PF03/EC	4058075277632	Endcap for Profile PF03	7.8x25.0x8.3	2	4
LS AY -PF03/MB	4058075276772	Mounting Bracket for Profile PF03	14.6x21.4x7.2	2	5

PROFILES FOR LED STRIPS

Product name	GTIN (EAN)	Product type	L x W x H [mm]		 No.
--------------	------------	--------------	----------------	---	---

Flat U-Shape Profile (12 mm wide), Aluminium



LS AY -PF04/U/17X7/12/1	4058075278288	Flat U-Shape Profile (12 mm wide), Aluminium	1000x17.0x7.0	1	1
LS AY -PF04/U/17X7/12/2	4058075401624	Flat U-Shape Profile (12 mm wide), Aluminium, 2 m long	2000x17.0x7.0	1	1
LS AY -PC/R01/D/1	4058075279360	Round Cover for Profiles PM05, PM06, PF03, PF04, diffuse	1000x15.2x4.7	1	2
LS AY -PC/R01/D/2	4058075401891	Round Cover for Profiles PM05, PM06, PF03, PF04, diffuse, 2 m long	2000x15.2x4.7	1	2
LS AY -PC/R01/C/1	4058075402256	Round Cover for Profiles PM05, PM06, PF03, PF04, clear	1000x15.2x4.7	1	-
LS AY -PC/R01/C/2	4058075402072	Round Cover for Profiles PM05, PM06, PF03, PF04, clear, 2 m long	2000x15.2x4.7	1	-
LS AY -PF04/EC/H	4058075277724	Endcap with Hole for Profile PF04	6.4x17.3x8.3	2	3
LS AY -PF04/EC	4058075277694	Endcap for Profile PF04	6.4x17.3x8.3	2	4
LS AY -PF04/MB	4058075276857	Mounting Bracket for Profile PF04	14.6x21.4x7.2	2	5

Medium Profiles for LED Strips

Medium U-Shape Wing Profile, Aluminium

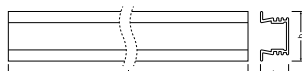













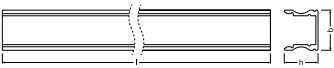







LS AY -PM01/UW/21,5X12/10/1	4058075278318	Medium U-Shape Wing Profile, Aluminium	1000x21.5x12.0	1	1
LS AY -PM01/UW/21,5X12/10/2	4058075401655	Medium U-Shape Wing Profile, Aluminium, 2 m long	2000x21.5x12.0	1	1
LS AY -PC/P02/D/1	4058075305762	Plain Cover for Profiles PF01, PM01, diffuse	1000x13.2x4.4	1	2
LS AY -PC/P02/D/2	4058075401860	Plain Cover for Profiles PF01, PM01, diffuse, 2 m long	2000x13.2x4.4	1	2
LS AY -PC/P02/C/1	4058075402225	Plain Cover for Profiles PF01, PM01, clear	1000x13.2x4.4	1	-
LS AY -PC/P02/C/2	4058075402041	Plain Cover for Profiles PF01, PM01, clear, 2 m long	2000x13.2x4.4	1	-
LS AY -PM01/EC/H	4058075277786	Endcap with Hole for Profile PM01	20.2x21.7x12.0	2	3
LS AY -PM01/EC	4058075277755	Endcap for Profile PM01	20.2x21.7x12.0	2	4
LS AY -PM01/MB	4058075276888	Mounting Bracket for Profile PM01	20x18.8x7.2	2	5

Medium U-Shape Wing Profile (15,5 mm high), Aluminium



LS AY -PM04/UW/23X15,5/10/1	4058075278400	Medium U-Shape Wing Profile (15,5 mm high), Aluminium	1000x23.0x15.5	1	1
LS AY -PM04/UW/23X15,5/10/2	4058075401747	Medium U-Shape Wing Profile (15,5 mm high), Aluminium, 2 m long	2000x23.0x15.5	1	1
LS AY -PC/R02/D/1	4058075305793	Round Cover for Profile PM04, diffuse	1000x15.6x4.4	1	2
LS AY -PC/R02/D/2	4058075401921	Round Cover for Profile PM04, diffuse, 2 m long	2000x15.6x4.4	1	2
LS AY -PC/R02/C/1	4058075402287	Round Cover for Profile PM04, clear	1000x15.6x4.4	1	-
LS AY -PC/R02/C/2	4058075402102	Round Cover for Profile PM04, clear, 2 m long	2000x15.6x4.4	1	-
LS AY -PM04/EC/H	4058075275836	Endcap with Hole for Profile PM04	10x23.0x14.4	2	3
LS AY -PM04/EC	4058075277939	Endcap for Profile PM04	10x23.0x14.4	2	4
LS AY -PM04/MB	4058075276970	Mounting Bracket for Profile PM04	15x18.5x10.6	2	5

PROFILES FOR LED STRIPS

Product name	GTIN (EAN)	Product type	L x W x H [mm]		 No.
Medium U-Shape Profile, Aluminium					
					
	1	2	3	4	5
LS AY -PM05/U/17,5X14,5/10/1	4058075279278	Medium U-Shape Profile, Aluminium	1000x17.5x14.5	1	1
LS AY -PM05/U/17,5X14,5/10/2	4058075401778	Medium U-Shape Profile, Aluminium, 2 m long	2000x17.5x14.5	1	1
LS AY -PC/R01/D/1	4058075279360	Round Cover for Profiles PM05, PM06, PF03, PF04, diffuse	1000x15.2x4.7	1	2
LS AY -PC/R01/D/2	4058075401891	Round Cover for Profiles PM05, PM06, PF03, PF04, diffuse, 2 m long	2000x15.2x4.7	1	2
LS AY -PC/R01/C/1	4058075402256	Round Cover for Profiles PM05, PM06, PF03, PF04, clear	1000x15.2x4.7	1	-
LS AY -PC/R01/C/2	4058075402072	Round Cover for Profiles PM05, PM06, PF03, PF04, clear, 2 m long	2000x15.2x4.7	1	-
LS AY -PM05/EC/H	4058075276529	Endcap with Hole for Profile PM05	6.7x17.3x20.0	2	3
LS AY -PM05/EC	4058075275867	Endcap for Profile PM05	6.7x17.3x20.0	2	4
LS AY -PM05/MB	4058075277007	Mounting Bracket for Profile PM05	14.6x21.4x7.2	2	5
Medium Round Shape Profile, Aluminium					
					
	1	2	3	4	5
LS AY -PM02/R/18X15,5/10/1	4058075278349	Medium Round Shape Profile, Aluminium	1000x18.0x15.5	1	1
LS AY -PM02/R/18X15,5/10/2	4058075401686	Medium Round Shape Profile, Aluminium, 2 m long	2000x18.0x15.5	1	1
LS AY -PC/P01/D/1	4058075279339	Plain Cover for Profiles PF02, PM02, PM03, diffuse	1000x12.7x4.4	1	2
LS AY -PC/P01/D/2	4058075401839	Plain Cover for Profiles PF02, PM02, PM03, diffuse, 2 m long	2000x12.7x4.4	1	2
LS AY -PC/P01/C/1	4058075402195	Plain Cover for Profiles PF02, PM02, PM03, clear	1000x12.7x4.4	1	-
LS AY -PC/P01/C/2	4058075402010	Plain Cover for Profiles PF02, PM02, PM03, clear, 2 m long	2000x12.7x4.4	1	-
LS AY -PM02/EC/H	4058075277847	Endcap with Hole for Profile PM02	11.5x18.1x15.6	2	3
LS AY -PM02/EC	4058075277816	Endcap for Profile PM02	11.5x18.1x15.6	2	4
LS AY -PM02/MB	4058075276918	Mounting Bracket for Profile PM02	20x18.8x7.2	2	5
Medium Edge Shape Profile, Aluminium					
					
	1	2	3	4	5
LS AY -PM03/E/19X19/10/1	4058075278370	Medium Edge Shape Profile, Aluminium	1000x19.0x19.0	1	1
LS AY -PM03/E/19X19/10/2	4058075401716	Medium Edge Shape Profile, Aluminium, 2 m long	2000x19.0x19.0	1	1
LS AY -PC/P01/D/1	4058075279339	Plain Cover for Profiles PF02, PM02, PM03, diffuse	1000x12.7x4.4	1	2
LS AY -PC/P01/D/2	4058075401839	Plain Cover for Profiles PF02, PM02, PM03, diffuse, 2 m long	2000x12.7x4.4	1	2
LS AY -PC/P01/C/1	4058075402195	Plain Cover for Profiles PF02, PM02, PM03, clear	1000x12.7x4.4	1	-
LS AY -PC/P01/C/2	4058075402010	Plain Cover for Profiles PF02, PM02, PM03, clear, 2 m long	2000x12.7x4.4	1	-
LS AY -PM03/EC/H	4058075277908	Endcap with Hole for Profile PM03	11.5x26.6x17.4	2	3
LS AY -PM03/EC	4058075277878	Endcap for Profile PM03	11.5x26.6x17.4	2	4
LS AY -PM03/MB	4058075276949	Mounting Bracket for Profile PM03	12x20.0x8.0	2	5

PROFILES FOR LED STRIPS

Product name	GTIN (EAN)	Product type	L x W x H [mm]		 No.
--------------	------------	--------------	----------------	---	---

Medium Edge Shape Profile (12 mm wide), Aluminium



LS AY -PM06/E/18X18/12/1	4058075279308	Medium Edge Shape Profile (12 mm wide), Aluminium	1000x18.0x18.0	1	1
LS AY -PM06/E/18X18/12/2	4058075401808	Medium Edge Shape Profile (12 mm wide), Aluminium, 2 m long	2000x18.0x18.0	1	1
LS AY -PC/R01/D/1	4058075279360	Round Cover for Profiles PM05, PM06, PF03, PF04, diffuse	1000x15.2x4.7	1	2
LS AY -PC/R01/D/2	4058075401891	Round Cover for Profiles PM05, PM06, PF03, PF04, diffuse, 2 m long	2000x15.2x4.7	1	2
LS AY -PC/R01/C/1	4058075402256	Round Cover for Profiles PM05, PM06, PF03, PF04, clear	1000x15.2x4.7	1	-
LS AY -PC/R01/C/2	4058075402072	Round Cover for Profiles PM05, PM06, PF03, PF04, clear, 2 m long	2000x15.2x4.7	1	-
LS AY -PM06/EC/H	4058075276581	Endcap with Hole for Profile PM06	6.4x18.1x18.1	2	3
LS AY -PM06/EC	4058075276550	Endcap for Profile PM06	6.4x18.1x18.1	2	4
LS AY -PM06/MB	4058075277038	Mounting Bracket for Profile PM06	14.3x19.8x19.8	2	5

LED STRIPS

STRIP ACCESSORIES

PROFILES

DRIVERS

RELIABLE AND VERSATILE

LEDVANCE LED DRIVERS FOR CONSTANT VOLTAGE

SUPERIOR
CLASS

PERFOR-
MANCE
CLASS

VALUE
CLASS

OUR DRIVER PORTFOLIO FITS EVERY NEED

Only with the right drivers for constant voltage (CV) can you unleash the full potential of modern lighting with LED Strips. At LEDVANCE you get everything from a single source.

The SELV-insulated constant voltage LED drivers from LEDVANCE are perfectly matched to LEDVANCE LED Strips. A portfolio of dimmable and non-dimmable versions for professional indoor and outdoor applications gives you a wide variety of combinations to cover virtually any requirements. Integrated cable clamps allow for easy installation, reducing your time and costs. Other strong arguments include the option of IP66 protection and a life of up to 50000 hours¹. Why should you settle for anything less?



The full range of LED drivers
for LED Strips:
[ledvance.com/ledstrip-drivers](https://www.ledvance.com/ledstrip-drivers)

¹ At max. Tc temperature

LED DRIVER DALI SUPERIOR



Constant voltage LED driver with DALI dimming interface



PRODUCT FEATURES

- 1 channel DALI-2 certified LED driver
- Cable clamp housing for independent mounting
- Operated with Safety extra-low voltage (SELV):
- Type of protection: IP20

PRODUCT BENEFITS

- Quick and comfortable installation thanks to tool-less cable clamp concept
- 5 years guarantee
- Low flickering enables high light quality as well as good visual comfort
- Push DIM application for easy control
- Optimized matched to 24 V LED flexible strips

AREAS OF APPLICATION

- Cove lighting, even in tight spaces
- Hotels, shops, hospitality, residential interiors
- Museums, art galleries
- Strip lighting in single and open-plan offices
- Suitable for use in emergency lighting systems (DC capable)

Product name	GTIN (EAN)	W	Hz	W	t _{th} ³	T _a	T _c	PROTECTION CLASS	L x W x H [mm]	Light bulb icon No.
DR DALI-SUP -45/220-240/24	4058075421820	45.0	50...60	1...100	50 000	-20...+50	85	II	229x47.0x32.0	1
DR DALI-SUP -80/220-240/24	4058075421844	80.0	50...60	1...100	50 000	-20...+45	85	II	330x47.0x32.0	2
DR DALI-SUP -150/220-240/24	4058075421868	150.0	50...60	1...100	50 000	-20...+45	85	II	330x47.0x32.0	3

¹ Refer to www.ledvance.com/guarantee for precise conditions | ² Dimmable with suitable drivers, see also www.ledvance.com/dim | ³ At maximum T_c / 10% failure rate

LED DRIVER SUP

Constant voltage longlife LED driver

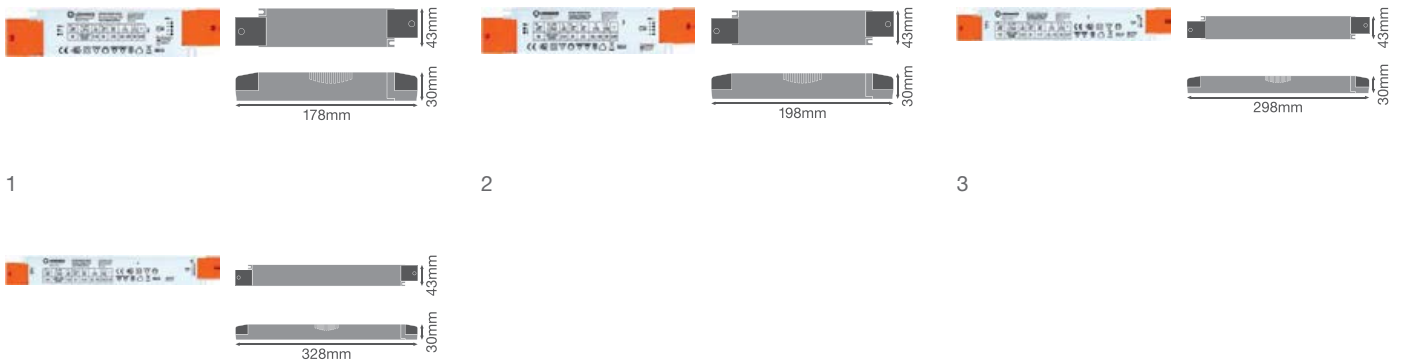

1

2

3

4



PRODUCT FEATURES

- Available in 30 W, 60 W, 100 W and 200 W
- Integrated cable clamp for independent installation
- Lifetime: up to 60,000 h (at max. tc temperature)
- Type of protection: IP20
- Low ripple current
- Supply voltage: 220...240 V
- Operating frequency: 50/60 Hz
- Operated with less than 60 V: Safety extra-low voltage (SELV)
- Reversible overtemperature, overload, short-circuit and open-circuit protection

PRODUCT BENEFITS

- Perfectly matched to 24 V LED flexible strips
- Long reliable life at maximum permitted temperatures
- 5 years guarantee
- Maintenance-free operation and minimal installation costs
- Quick and simple installation
- High efficiency and reliability

AREAS OF APPLICATION

- Cove lighting, even in tight spaces
- Wallwasher effect lighting in living rooms, dining rooms, bedrooms, entrances
- Offices, shopping centers, hospitals, restaurants, hotels
- For indoor SELV installations

Product name	GTIN (EAN)	W	Hz	W	t(h) ²	T _a	T _c	PROTECTION CLASS	L × W × H [mm]	Lightbulb No.
DR-SUP -30/220-240/24	4058075437784	30.0	50...60	-	60 000 ^{a)}	-20...+50	75	II	178x43.0x30.0	1
DR-SUP -60/220-240/24	4058075437807	60.0	50...60	-	60 000 ^{b)}	-20...+55	90	II	198x43.0x30.0	2
DR-SUP -100/220-240/24	4058075437821	100.0	50...60	-	60 000 ^{b)}	-20...+55	85	II	298x43.0x30.0	3
DR-SUP -200/220-240/24	4058075437845	200.0	50...60	-	60 000 ^{b)}	-20...+50	80	II	328x43.0x30.0	4

¹ Refer to www.ledvance.com/guarantee for precise conditions | ² a) At maximum T_c = 75°C / 10% failure rate; b) At maximum T_c = 80°C / 10% failure rate

LED DRIVER 1-10 V DIM OUTDOOR PERFORMANCE



Constant voltage outdoor LED driver with 1-10 V dimming interface

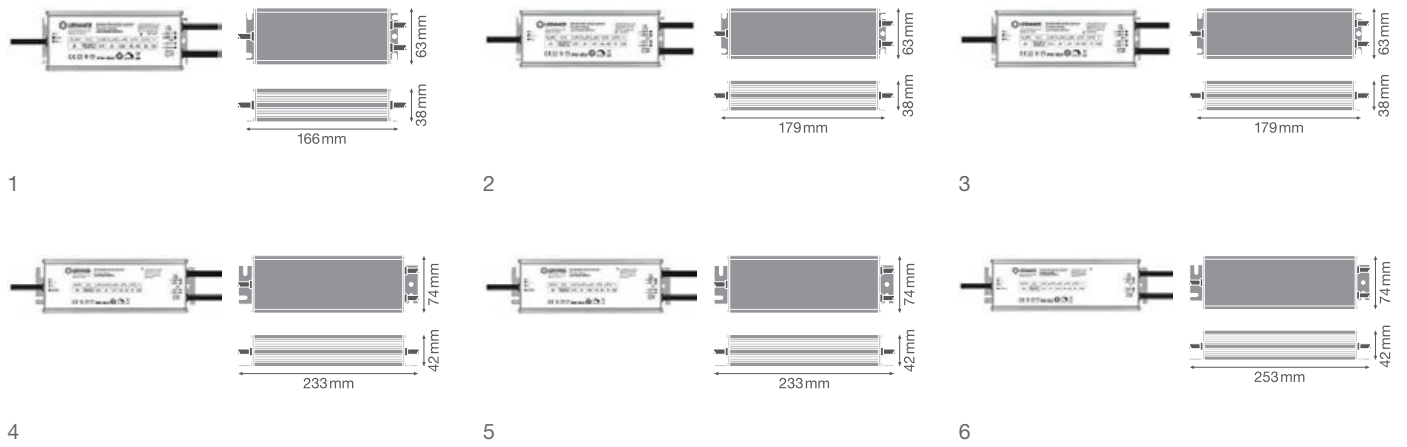

PRODUCT FEATURES

- Available in 20 W, 40 W, 60 W, 100 W, 150 W and 250 W
- Dimmable via 1...10 V dimming control
- Dimmable from 10...100 %
- Lifetime: up to 50,000 h (at max. t_c temperature)
- Type of protection: IP66
- Operating temperature range at t_a : -40...50 °C
- Supply voltage: 220...240 V
- Operating frequency: 50/60 Hz
- Surge protection: up to 6 kV (L-N), 6 kV (L/N-PE)
- Short-circuit and overload protection

PRODUCT BENEFITS

- Perfectly matched to 24 V LED flexible strips
- 5 years guarantee
- Very stable output power
- Quick and simple installation due to prewiring
- High efficiency and reliability
- Installation in very cold and hot environments

AREAS OF APPLICATION

- Suitable for indoor and outdoor installations
- Facade and building illumination
- Ideal for illuminating public spaces
- Bathrooms, kitchens and outdoor areas
- Offices, shopping centers, hospitals, restaurants, hotels

Product name	GTIN (EAN)	W	Hz	W	t_{th} ³	T_a	T_c	PROTECTION CLASS	L × W × H [mm]	Light bulb icon
DR DIM-PFM -20/220-240/24/P	4058075239951	20.0	50...60	10...100	50 000 ^{a)}	-40...+50	65	II	166x63.0x38.0	1
DR DIM-PFM -40/220-240/24/P	4058075379176	40.0	50...60	10...100	50 000 ^{b)}	-40...+50	75	II	179x63.0x38.0	2
DR DIM-PFM -60/220-240/24/P	4058075379190	60.0	50...60	10...100	50 000 ^{b)}	-40...+50	75	II	179x63.0x38.0	3
DR DIM-PFM -100/220-240/24/P	4058075240070	100.0	50...60	10...100	50 000 ^{c)}	-40...+50	70	I	233x74.0x42.0	4
DR DIM-PFM -150/220-240/24/P	4058075240117	150.0	50...60	10...100	50 000 ^{b)}	-40...+50	75	I	233x74.0x42.0	5
DR DIM-PFM -250/220-240/24/P	4058075240155	250.0	50...60	10...100	50 000 ^{d)}	-40...+50	85	I	253x74.0x42.0	6

¹ Refer to www.ledvance.com/guarantee for precise conditions | ² Dimmable with suitable drivers, see also www.ledvance.com/dim | ³ a) At maximum $T_c = 65^\circ\text{C}$ / 10% failure rate; b) At maximum $T_c = 75^\circ\text{C}$ / 10% failure rate; c) At maximum $T_c = 70^\circ\text{C}$ / 10% failure rate; d) At maximum $T_c = 85^\circ\text{C}$ / 10% failure rate

LED DRIVER OUTDOOR PERFORMANCE



Constant voltage outdoor LED driver

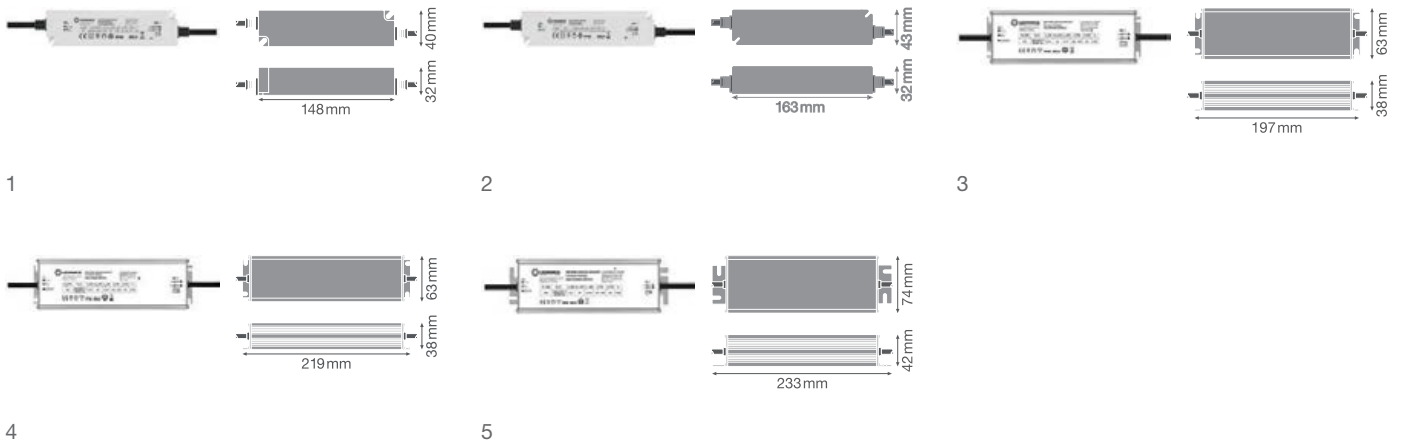

PRODUCT FEATURES

- Available in 30 W, 60 W, 100 W, 150 W and 250 W
- Lifetime: up to 50,000 h (at max. tc temperature)
- Type of protection: IP66
- Operating temperature range at ta: -40...50 °C
- Supply voltage: 220...240 V
- Operating frequency: 50/60 Hz
- Surge protection: up to 4 kV (L-N) for 30W/60W, 6 kV (L-N) / 6 kV (L/N-PE) for 100W/150W/250W
- Short-circuit and overload protection

PRODUCT BENEFITS

- Perfectly matched to 24 V LED flexible strips
- 5 years guarantee
- Very stable output power
- Quick and simple installation due to prewiring
- High efficiency and reliability
- Installation in very cold and hot environments

AREAS OF APPLICATION

- Suitable for indoor and outdoor installations
- Facade and building illumination
- Ideal for illuminating public spaces
- Bathrooms, kitchens and outdoor areas
- Offices, shopping centers, hospitals, restaurants, hotels

Product name	GTIN (EAN)	W	Hz	W	t(h) ²	Ta	Tc	PROTECTION CLASS	L x W x H [mm]	Light No.
DR-PFM -30/220-240/24/P	4058075239890	30.0	50...60	-	50 000 ^{a)}	-40...+50	80	II	148x40.0x32.0	1
DR-PFM -60/220-240/24/P	4058075239913	60.0	50...60	-	50 000 ^{b)}	-40...+50	90	II	163x43.0x32.0	2
DR-PFM -100/220-240/24/P	4058075239937	100.0	50...60	-	50 000 ^{a)}	-40...+50	80	I	197x63.0x38.0	3
DR-PFM -150/220-240/24/P	4058075239975	150.0	50...60	-	50 000 ^{b)}	-40...+50	90	I	219x63.0x38.0	4
DR-PFM -250/220-240/24/P	4058075240032	250.0	50...60	-	50 000 ^{c)}	-40...+50	85	I	233x74.0x42.0	5

¹ Refer to www.ledvance.com/guarantee for precise conditions | ² a) At maximum T_c = 80°C / 10% failure rate; b) At maximum T_c = 90°C / 10% failure rate; c) At maximum T_c = 85°C / 10% failure rate

LED DRIVER VALUE



Constant voltage LED driver

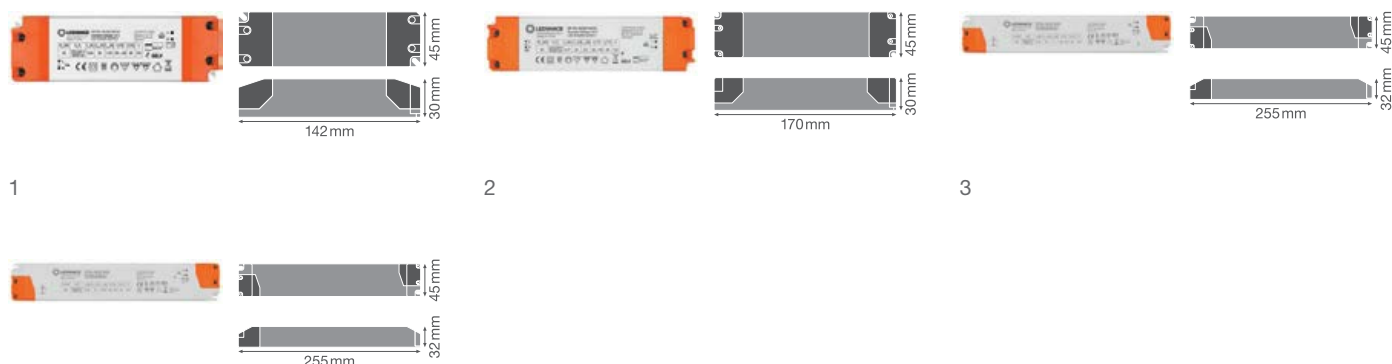

PRODUCT FEATURES

- Available in 30 W, 60 W, 120 W and 150 W
- Integrated cable clamp for independent installation
- Lifetime: up to 35,000 h at max. tc temperature)
- Type of protection: IP20
- Low ripple current
- Supply voltage: 220...240 V
- Operating frequency: 50/60 Hz
- Operated with less than 60 V: Safety extra-low voltage (SELV)
- Reversible overtemperature, overload, short-circuit and open-circuit protection

PRODUCT BENEFITS

- Perfectly matched to 24 V LED flexible strips
- Excellent price/performance ratio
- 3 years guarantee
- Quick and simple installation
- Good efficiency and reliability

AREAS OF APPLICATION

- Cove lighting, even in tight spaces
- Wallwasher effect lighting in living rooms, dining rooms, bedrooms, entrances
- For indoor SELV installations
- Offices, shopping centers, hospitals, restaurants, hotels

Product name	GTIN (EAN)	W	Hz	W	t(h) ²	T _a	T _c	PROTECTION CLASS	L × W × H [mm]	Lightbulb No.
DR-VAL -30/220-240/24	4058075240056 ³⁾	30.0	50...60	-	35 000 ^{a)}	-20...+45	85	II	142x45.0x30.0	1
DR-VAL -60/220-240/24	4058075240094 ⁴⁾	60.0	50...60	-	35 000 ^{a)}	-20...+45	85	II	170x45.0x30.0	2
DR-VAL -120/220-240/24	4058075240131 ⁵⁾	120.0	50...60	-	35 000 ^{b)}	-20...+40	90	II	255x45.0x32.0	3
DR-VAL -150/220-240/24	4058075240179 ⁶⁾	150.0	50...60	-	35 000 ^{c)}	-20...+40	90	II	255x45.0x32.0	4

¹ Refer to www.ledvance.com/guarantee for precise conditions | ² a) At maximum T_c = 85°C / 10% failure rate; b) At maximum T_c = 90°C / 10% failure rate; c) At maximum T_c = 90°C / 12% failure rate | ³ New EAN 4058075754928 from June 2022 | ⁴ New EAN 4058075754959 from June 2022 | ⁵ New EAN 4058075754980 from June 2022 | ⁶ New EAN 4058075755000 from June 2022

COMPATIBILITY OVERVIEW FOR LED STRIPS AND DRIVERS

LED STRIP	DRIVERS	DR DALI-SUP-45/220-240/24	DR DALI-SUP-80/220-240/24	DR DALI-SUP-150/220-240/24	DR-SUP-30/220-240/24	DR-SUP-60/220-240/24	DR-SUP-100/220-240/24	DR-SUP-200/220-240/24	DR DIM-PFM-20/220-240/24/P	DR DIM-PFM-40/220-240/24/P	DR DIM-PFM-60/220-240/24/P	DR DIM-PFM-100/220-240/24/P	DR DIM-PFM-150/220-240/24/P	DR DIM-PFM-250/220-240/24/P	DR-PFM-30/220-240/24/P	DR-PFM-60/220-240/24/P	DR-PFM-100/220-240/24/P	DR-PFM-150/220-240/24/P	DR-PFM-250/220-240/24/P	DR-VAL-30/220-240/24	DR-VAL-60/220-240/24	DR-VAL-120/220-240/24	DR-VAL-150/220-240/24	
SUPERIOR CLASS TW																								
LS SUP-2000/TW								■					■	■						■	■			
LS SUP-2000/TW IP67								■					■	■						■	■			
PERFORMANCE CLASS COB																								
LS PFM-1000/COB		■	■	■	■	■	■	■	■	■	■	■	■	■	■	■	■	■	■	■	■	■	■	■
PERFORMANCE CLASS WHITE																								
LS P-500		■	■	■	■	■	■	■	■	■	■	■	■	■	■	■	■	■	■	■	■	■	■	■
LS P-500 IP67		■	■	■	■	■	■	■	■	■	■	■	■	■	■	■	■	■	■	■	■	■	■	■
LS P-1000		■	■	■	■	■	■	■	■	■	■	■	■	■	■	■	■	■	■	■	■	■	■	■
LS P-1000 IP67		■	■	■	■	■	■	■	■	■	■	■	■	■	■	■	■	■	■	■	■	■	■	■
LS P-1500		■	■	■	■	■	■	■	■	■	■	■	■	■	■	■	■	■	■	■	■	■	■	■
LS P-1500 IP67		■	■	■	■	■	■	■	■	■	■	■	■	■	■	■	■	■	■	■	■	■	■	■
LS P-2000		■	■	■	■	■	■	■	■	■	■	■	■	■	■	■	■	■	■	■	■	■	■	■
LS P-2000 IP67		■	■	■	■	■	■	■	■	■	■	■	■	■	■	■	■	■	■	■	■	■	■	■
VALUE CLASS WHITE																								
LS V-500		■	■	■	■	■	■	■	■	■	■	■	■	■	■	■	■	■	■	■	■	■	■	■
LS V-500 IP66		■	■	■	■	■	■	■	■	■	■	■	■	■	■	■	■	■	■	■	■	■	■	■
LS V-1000		■	■	■	■	■	■	■	■	■	■	■	■	■	■	■	■	■	■	■	■	■	■	■
LS V-1000 IP66		■	■	■	■	■	■	■	■	■	■	■	■	■	■	■	■	■	■	■	■	■	■	■
LS V-1500		■	■	■	■	■	■	■	■	■	■	■	■	■	■	■	■	■	■	■	■	■	■	■
LS V-1500 IP66		■	■	■	■	■	■	■	■	■	■	■	■	■	■	■	■	■	■	■	■	■	■	■
LS V-2000		■	■	■	■	■	■	■	■	■	■	■	■	■	■	■	■	■	■	■	■	■	■	■
LS V-2000 IP66		■	■	■	■	■	■	■	■	■	■	■	■	■	■	■	■	■	■	■	■	■	■	■
VALUE CLASS WHITE BIG REEL																								
LS VAL-600/50		■	■	■	■	■	■	■	■	■	■	■	■	■	■	■	■	■	■	■	■	■	■	■
LS VAL-600/30/IP65		■	■	■	■	■	■	■	■	■	■	■	■	■	■	■	■	■	■	■	■	■	■	■
LS VAL-1400/50		■	■	■	■	■	■	■	■	■	■	■	■	■	■	■	■	■	■	■	■	■	■	■
LS VAL-1400/30/IP65		■	■	■	■	■	■	■	■	■	■	■	■	■	■	■	■	■	■	■	■	■	■	■
PERFORMANCE CLASS RGBW																								
LS PFM-1000/RGBW									■	■		■	■	■			■	■	■				■	■
LS PFM-1000/RGBW IP66									■	■		■	■	■			■	■	■				■	■
VALUE CLASS RGB																								
LS VAL-500/RGB									■	■		■	■	■			■	■	■				■	■
LS VAL-500/RGB IP65									■	■		■	■	■			■	■	■				■	■

THE LONGER THE SHORTER LED STRIP LENGTH DEPENDING ON SUPPLY LINE LENGTH¹

The maximum length of an LED Strip varies from application to application and strongly depends on the supply line between the driver and the strip. Depending on the length and cross-section of this supply line, a voltage drop can be recorded which from a certain point will have a negative effect on the performance of the LED Strips. The tables below provide guide values.

MAX. FEED LENGTH – LED STRIPS SUPERIOR CLASS TUNABLE WHITE

Cable length (cross-section 0.5 mm ²) ³	Product class	Max. LED Strip length at an ambient temperature of T _a : 25 °C				
		<0.5 m	1.0 m	3.0 m	6.0 m	10.0 m
LS SUP-2000/TW/927-965/5	■	7.0 m	7.0 m	6.5 m	5.5 m	4.5 m
LS SUP-2000/TW/927-965/5/IP66 ²	■	7.0 m	7.0 m	6.5 m	5.5 m	4.5 m

MAX. FEED LENGTH – LED STRIPS PERFORMANCE CLASS COB

Cable length (cross-section 0.5 mm ²) ³	Product class	Max. LED Strip length at an ambient temperature of T _a : 25 °C				
		<0.5 m	1.0 m	3.0 m	6.0 m	10.0 m
LS PFM-1000/COB/9**/5 ⁴	■	5.0 m	4.8 m	4.5 m	4.1 m	3.4 m

MAX. FEED LENGTH – LED STRIPS PERFORMANCE CLASS

Cable length (cross-section 0.5 mm ²) ³	Product class	Max. LED Strip length at an ambient temperature of T _a : 25 °C				
		<0.5 m	1.0 m	3.0 m	6.0 m	10.0 m
LS PFM-500/8xx/5	■	10.1 m	9.8 m	9.4 m	8.8 m	7.9 m
LS PFM-1000/8xx/5	■	8.5 m	8.3 m	7.9 m	7.3 m	6.3 m
LS PFM-1500/8xx/5	■	7.3 m	7.0 m	6.6 m	6.1 m	5.3 m
LS PFM-2000/8xx/5	■	6.0 m	5.7 m	5.3 m	4.7 m	4.0 m
LS PFM-500/8xx/5/IP67 ²	■	10.1 m	9.8 m	9.4 m	8.8 m	7.9 m
LS PFM-1000/8xx/5/IP67 ²	■	8.5 m	8.3 m	7.9 m	7.3 m	6.3 m
LS PFM-1500/8xx/5/IP67 ²	■	7.3 m	7.0 m	6.6 m	6.1 m	5.3 m
LS PFM-2000/8xx/5/IP67 ²	■	6.0 m	5.7 m	5.3 m	4.7 m	4.0 m

MAX. FEED LENGTH – LED STRIPS VALUE CLASS

Cable length (cross-section 0.5 mm ²) ³	Product class	Max. LED Strip length at an ambient temperature of T _a : 25 °C				
		<0.5 m	1.0 m	3.0 m	6.0 m	10.0 m
LS VAL-500/8xx/5 ⁴	■	14.9 m	14.5 m	14.0 m	13.4 m	12.8 m
LS VAL-1000/8xx/5 ⁴	■	11.2 m	10.9 m	10.5 m	10.0 m	9.2 m
LS VAL-1500/8xx/5 ⁴	■	10.3 m	9.9 m	9.4 m	8.7 m	7.8 m
LS VAL-2000/8xx/5 ⁴	■	9.2 m	8.9 m	8.4 m	7.7 m	6.8 m
LS VAL-500/8xx/5/IP65 ^{2,4}	■	14.9 m	14.5 m	14.0 m	13.4 m	12.8 m
LS VAL-1000/8xx/5/IP65 ^{2,4}	■	11.2 m	10.9 m	10.5 m	10.0 m	9.2 m
LS VAL-1500/8xx/5/IP65 ^{2,4}	■	10.3 m	9.9 m	9.4 m	8.7 m	7.8 m
LS VAL-2000/8xx/5/IP65 ^{2,4}	■	9.2 m	8.9 m	8.4 m	7.7 m	6.8 m

MAX. FEED LENGTH – LED STRIPS VALUE CLASS BIG REEL

Cable length (cross-section 0.5 mm ²) ³	Product class	Max. LED Strip length at an ambient temperature of T _a : 25 °C				
		<0.5 m	1.0 m	3.0 m	6.0 m	10.0 m
Product name						
LS VAL-600/8xx/50 ⁴	■	13.2 m	12.8 m	12.5 m	12.0 m	11.2 m
LS VAL-1400/8xx/50 ⁴	■	13.3 m	12.9 m	12.6 m	12.0 m	10.7 m
LS VAL-600/8xx/30/IP65 ^{2,4}	■	13.2 m	12.8 m	12.5 m	12.0 m	11.2 m
LS VAL-1400/8xx/30/IP65 ^{2,4}	■	13.3 m	12.9 m	12.6 m	12.0 m	10.7 m

MAX. FEED LENGTH – LED STRIPS PERFORMANCE CLASS RGBW

Cable length (cross-section 0.5 mm ²) ³	Product class	Max. LED Strip length at an ambient temperature of T _a : 25 °C				
		<0.5 m	1.0 m	3.0 m	6.0 m	10.0 m
Product name						
LS PFM-1000/RGBW/8xx/5	■	7.0 m	6.2 m	5.6 m	4.8 m	4.0 m
LS PFM-1000/RGBW/8xx/5/IP66 ²	■	7.0 m	6.2 m	5.6 m	4.8 m	4.0 m

MAX. FEED LENGTH – LED STRIPS VALUE CLASS RGB

Cable length (cross-section 0.5 mm ²) ³	Product class	Max. LED Strip length at an ambient temperature of T _a : 25 °C				
		<0.5 m	1.0 m	3.0 m	6.0 m	10.0 m
Product name						
LS VAL-500/RGB/5 ⁴	■	10.0 m	9.6 m	9.1 m	8.7 m	7.7 m
LS VAL-500/RGB/5/IP65 ^{2,4}	■	10.0 m	9.6 m	9.1 m	8.7 m	7.7 m

DID YOU KNOW?

The configurator calculates the feeds for your individual LED Strip System based on your inputs.
Give it a try at: ledvance.com/led-strip-configurator



Summary of your Flex configuration

⊖ = no. of electrical connection points and, therefore, also drivers/ ballasts. Please, provide enough room for the operational gear!

No. of feed-ins ⊖ 2

max. power (W) 120

Desired length (m) 10

Length (m) ⊖

10,00 (m)

For more information about our products, please visit ledvance.com/led-strip

Or contact us at contact@ledvance.com



¹ The values given provide an overview of the change in the maximum operable LED Strip length depending on the supply line length with a cable cross-section of 0.5 mm². All values refer to an LED Strip rated voltage of 24 V_{DC} at the supply line. The supply line must be standard-compliant, regardless of the values. | ² If the LED Strip is extended by soldering, the installer is responsible for maintaining IP67, IP66 and IP65 protection. | ³ LED Strip connected to supply line with 500 mm LED Strip prewiring. | ⁴ In the case of resistance-controlled LED Strips, the drop in voltage at the resistors can cause a fall in brightness over the entire operable LED Strip length.

LIGHTING CONTROL FROM OSRAM: DYNAMICS MEETS EFFICIENCY

THE SYSTEM APPROACH TO GOOD LIGHT

Light management systems (LMS) comprise all the components needed for dynamic and intelligent lighting in addition to LED strips. These include LED drivers (CV) with DALI interfaces suitable for LED strips. Other components in light management systems also ensure that the LED strips are operated at high levels of comfort, convenience and energy efficiency. For example, light and motion sensors dim the light as soon as a room is lit by natural light, and only switch on the light if someone is in the room. Considerable energy savings can therefore be achieved.

OSRAM CONTROLLERS



DALI PCU PUSHBUTTON CONTROLLER

DALI MCU DIGITAL ROTARY DIMMER

DALI MCU TW DIGITAL ROTARY DIMMER TUNABLE WHITE



Product name	DALI PCU	DALI MCU	DALI MCU TW
GTIN (EAN)	4052899955622	4008321189721	4052899465916
Brief description	<ul style="list-style-type: none"> Manual dimming and switching of DALI luminaires via standard pushbutton Integrated DALI supply Integration in flush device boxes Parallel connection of up to 4 devices 	<ul style="list-style-type: none"> Manual dimming and switching of DALI luminaires Integrated DALI supply Parallel connection of up to 4 devices Combination with covers of various manufacturers 	<ul style="list-style-type: none"> Intuitive manual dimming, switching and color temperature setting of DALI luminaires with DALI Device Type 8 (DT8) Parallel connection of up to 4 devices Individual setting of minimum brightness level and color temperature range
L x W x H [mm]	48 x 48 x 22	80 x 80 x 50	80 x 80 x 50



DALI ACU BT DALI CONTROLLER WITH BLUETOOTH INTERFACE

DALIeco BT DALI CONTROLLER WITH BLUETOOTH INTERFACE

OT BLE DIM CONSTANT-VOLTAGE DIMMER WITH BLUETOOTH INTERFACE



Product name	DALI ACU BT	DALIeco BT	ECO CI KIT (optional)	OT BLE DIM
GTIN (EAN)	4052899544819	4052899988781	4008321392091	4052899557833
Brief description	<ul style="list-style-type: none"> Configuration and control via pushbutton and/or app Control of standard white or Tunable White light according to DALI Device Type 8 (DT8) Individual addressing of up to 4 groups Supports OSRAM DALI sensors Integration in flush device boxes 	<ul style="list-style-type: none"> Configuration and control via pushbutton and/or app Control of standard white or Tunable White light according to DALI Device Type 8 (DT8) Individual addressing of up to 4 groups Supports OSRAM DALI sensors For luminaire integration or independent mounting with CI KIT 		<ul style="list-style-type: none"> Control of LED modules in white, Tunable White, RGB or RGBW colors Supports systems based on the Casambi lighting control system Very low maintenance requirements
L x W x H [mm]	49 x 48 x 22	108 x 30 x 21	—	172 x 42 x 20



DALIeco BT RTC DALI CONTROLLER WITH BLUETOOTH INTERFACE

DALI PRO CONT-4 RTC CONTROLLER (9TE)



Product name	DALIeco BT RTC	DALI PRO CONT-4 RTC
GTIN (EAN)	4062172016537	4008321710871
Brief description	Like DALIeco BT, plus: <ul style="list-style-type: none"> Real-time clock for time-of-day-dependent automatic control of brightness and color temperature (HCL) Intuitive manual dimming, switching and color temperature setting 4 configurable timers 	<ul style="list-style-type: none"> Extremely flexible and configurable in many details Easy and intuitive control via app Connection of up to 4 DALI PROFESSIONAL controllers Extremely flexible, convenient configuration with PC software Supports DALI sensors
L x W x H [mm]	108 x 30 x 21	90 x 160 x 62

VIVARES LIGHT MANAGEMENT MORE COMFORTABLE THAN EVER

VIVARES is the future-proof IoT light management system from LEDVANCE. It creates ideal lighting conditions for all office applications more easily than ever before. The system is not only extremely reliable and compatible but also very flexible. From LMS components to matching LED luminaires, LED Strips and SMART⁺ lamps, it offers you everything from a single source and is also easy to install. Another advantage is the optional cloud connection for creating maintenance and energy consumption reports.

VIVARES ZIGBEE – WIRELESS, MODERN, FLEXIBLE

- Ideal for modernizing existing buildings where no rewiring is needed
- Based on the international Zigbee 3.0 standard
- Quick and easy installation and QR code-based commissioning
- Simple reconfiguration of the components when the use of rooms changes
- Maintenance and energy consumption reports from anywhere

VIVARES DALI – WIRED INDUSTRY STANDARD REDEFINED

- Tailor-made for new buildings and renovations with the option of additional control lines
- Products certified according to DALI-2 standard
- Extensive product portfolio for office applications
- Project creation and commissioning with self-explanatory software
- Integrated IoT gateway for maintenance and energy consumption reports

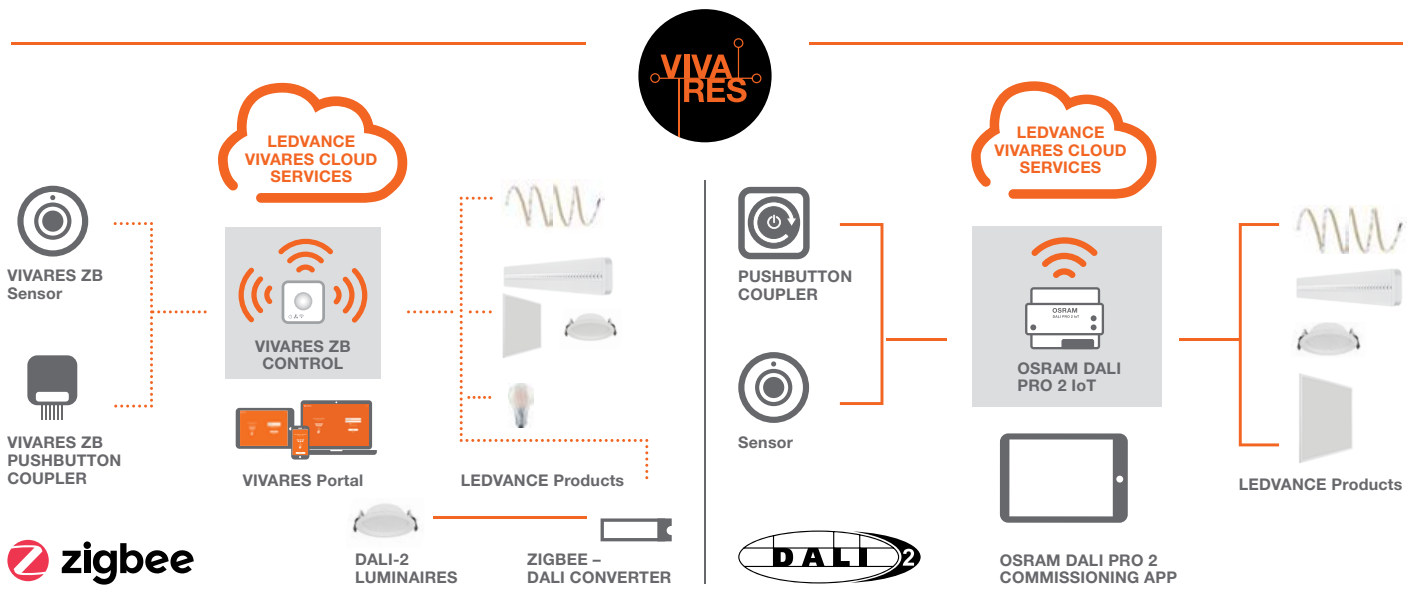

TAILOR-MADE SERVICE

Our VIVARES experts support you at all stages of your project – from planning and installation, commissioning and training, to ongoing operation and potential reconfiguration.

Take advantage of our service for your projects and get in touch by phone on +49 89 780673-660 or by email to contact@ledvance.com

MORE INFORMATION

online at: ledvance.com/vivares

Discover product training, commissioning instructions and much more on our YouTube channel.



[ledvance.com/
zigbeevideos](https://ledvance.com/zigbeevideos)



[ledvance.com/
dalivideos](https://ledvance.com/dalivideos)

LIGHT AND SPACE ART INSTALLATION IN THE MUNICH PROPYLAEA

**“THERE ARE TIMES WHEN ART
AND CULTURE NEED MORE
SPACE THAN JUST AN IDEA”.**

Yul Zeser, creator of the art installation
in the Propylaea.



For the “Kunstareal verbindet” initiative, the city of Munich used the Propylaea on Königsplatz designed by Leo von Klenze to stage an impressive lighting show. The technology was supplied by LEDVANCE – including Value 500 RGB Protected LED Strips.

THE CHALLENGE

The aim of the art initiative was to bring out Klenze’s architecture through modern lighting design. To cope with the enormous dimensions of the Propylaea, a particularly powerful lighting system had to be found: wind- and weather-resistant, suitable for continuous use at low temperatures, and with a constant color temperature and luminous intensity. And the lighting technology needed to be seamlessly integrated into the existing architecture.

THE SOLUTION

The city of Munich opted for ECO HIGH POWER FLOODLIGHT 500 W and VALUE 500 RGB PROTECTED LED Strips. Both products are renowned for their high luminous intensity and homogeneity in combination with a low installation profile, perfect for continuous outdoor use (IP65) and also extremely efficient. In total, the LEDVANCE luminaires illuminated the Propylaea with a luminous intensity of over 1 million lumens.

LIGHT AND ARCHITECTURE BECOME ONE:

ECO HIGH POWER FLOODLIGHTS with a wide beam angle were used as the main light source for the large areas.

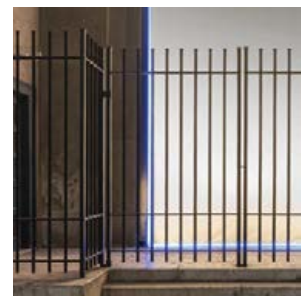
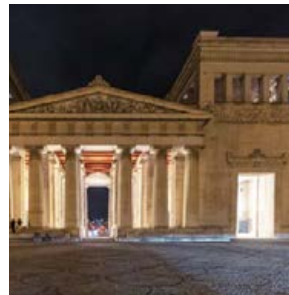

SEAMLESS TRANSITION WITH LIGHT:

VALUE RGB LED Strips gave all the archways of the Propylaea an effective blue frame.

For more details on the project visit:
ledvance.com/projects



TAILOR-MADE LIGHTING DESIGN

TAKE ADVANTAGE OF THE SERVICE OFFERED BY LEDVANCE

PROFESSIONAL LIGHTING DESIGN

DIALUX AND RELUX

LEDVANCE is collaborating with the developers of DIALux and RELUX software. So you can now easily integrate LEDVANCE products in your lighting plans. Our luminaire data is also BIM-compatible.

EVEN MORE CONVENIENT

LEDVANCE takes care of tailor-made calculations and offers you a customized solution for your lighting requirements – all from a single source.

YOUR BENEFITS AT A GLANCE

- Uniformly good light distribution
- Precise wattage per sqm
- Maximum efficient calculation of required light sources

LED STRIP SYSTEM CONFIGURATOR

Step by step to a customized solution – the intuitive LED Strip System Configurator is the easy way for you to plan any lighting project. Just define the lighting requirements, mounting type, accessories, operating mode and drivers one by one. At the end, you will receive a summary with all the necessary components and useful information about mounting and installation.

Try it straightaway at [ledvance.com/led-strip-configurator*](https://ledvance.com/led-strip-configurator)

ASSEMBLE-TO-ORDER – INDIVIDUAL LIGHT IN NO TIME



Modular designs that are quick and easy to assemble are the key to this concept. This means that we are already in a position to tailor certain special solutions to your needs.

These individual lighting solutions are provided in consultation with us so please contact us.



Take advantage of our services for your projects and get in touch at:

Email: contact@ledvance.com

Phone: +49 89 780673-660

* The LED Strip System Configurator is no substitute for comprehensive professional planning with DIALux and RELUX or other professional light planning software.

WHENEVER AND WHEREVER: THE ONLINE PORTAL WITH ALL THE INFORMATION, ADVICE AND EXPERTISE

Are you looking for information about our products and services? LEDVANCE always keeps you up to date: at wholesalers, through our sales employees or via our Customer Service Center (email: contact@ledvance.com). Here you'll find an overview of our expertise, databases and tools.

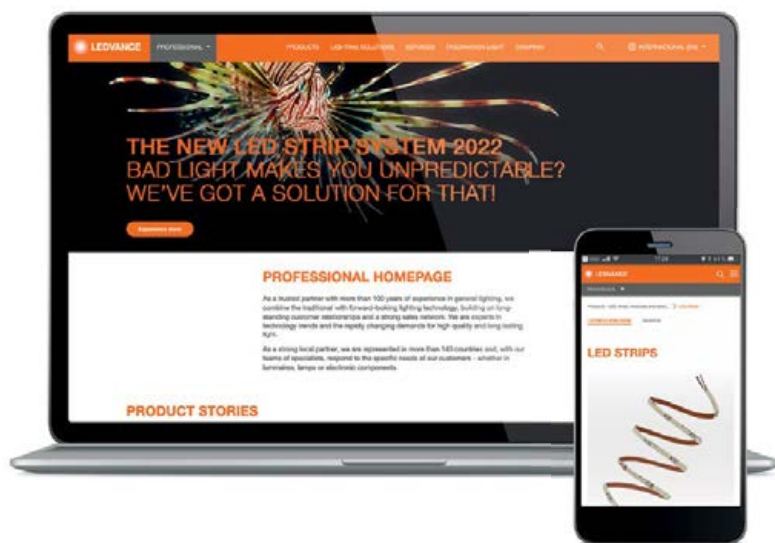

▶ PERFECTLY INFORMED

You can find all the information, applications and segmentations relating to our new LED Strip System at ledvance.com/led-strip

▶ REFERENCES PROVIDE INSPIRATION

A selection of some top lighting projects can be found at ledvance.com/projects

▶ LEDVANCE SERVICE-PLUS

Our specialized sales department supports and advises our commercial end customers – including face-to-face. Find out all you need to know at ledvance.com/vam

▶ DOWNLOAD CENTER

Catalogs, compatibility overviews, brochures, and much more are available for you in our download center: ledvance.com/download

▶ OUR TOOLS FOR YOU

From the LED strip system configurator to the TCO calculator for lamps, you will find all the practical tools you need at ledvance.com/tools

▶ SERVICE AT A GLANCE

You will find a summary of all of our service offerings at ledvance.com/services

▶ Find our latest news on:

LEDVANCE TRAINING CENTER: DEEPER KNOWLEDGE MADE EASY

Learn all you need to know about technology, products and applications. And discover the world of light in an interactive and interesting way.

Simply register at training.ledvance.com

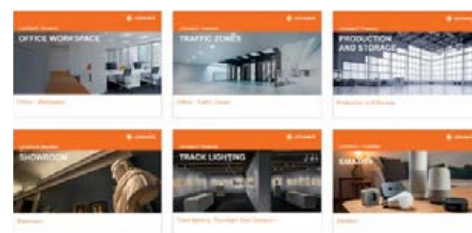

Current training courses are shown in a clear and self-explanatory layout. This allows you to dive right into the topic you want to learn about, refresh your knowledge and discover new things.

TIPS AND TRICKS FOR DIFFERENT APPLICATIONS

- Office: How lighting in the workplace can contribute to the well-being of employees
- Traffic zones: How light provides orientation in corridors and helps avoid trip hazards in stairwells
- Industry: How to illuminate production and warehouse areas in an energy-efficient and standard-compliant manner
- Retail area: How to turn consumers' eyes and attract attention in retail areas
- Product highlights: How track lighting can be attractive today



GOOD LIGHT ALL ROUND

THE FULL LEDVANCE RANGE

LEDVANCE is leading the fight against bad light in every area. That's good news for you because when it comes to future-proof solutions relating to luminaires and lamps, HCL systems, electronic components, light management and smart residential products, you have a competent partner in LEDVANCE on your side for your complex lighting projects. You can always rely on LEDVANCE for excellent brand quality, professional service and a good price/performance ratio.



AESTHETICALLY FUNCTIONAL LUMINAIRES

The extensive luminaire portfolio covers virtually all professional and residential applications and delivers outstanding quality and functionality. The new BIOLUX HCL system is a winner of the VDE Quality Certificate, and the red dot 2020 Product Design and 2020 German Innovation Awards.

EACH LAMP A LIGHTING SOLUTION

The lamp portfolio includes a wide choice of shapes and base sizes as well as types with additional functions (e.g. sensors), all with outstanding efficiency and durability. Alongside UV-C and LED lamps, LEDVANCE will continue to offer conventional halogen, energy-saving, fluorescent and gas discharge lamps.

FLEXIBLE LED STRIP SYSTEM

The LED Strip System includes a large number of flexible LED strips, drivers and matching accessories. With a wide range of luminous fluxes and light colors, the system allows bespoke lighting solutions to be created for virtually any indoor or outdoor application. Easy to plan, easy to combine and easy to install – that's the principle here.

VIVARES: LIGHT MANAGEMENT, MORE COMFORTABLE THAN EVER

The future-proof IoT light management system (LMS) from LEDVANCE makes it easier and more flexible than ever to always produce optimal lighting conditions for defined requirements. The system is extremely reliable and compatible and offers all LMS components and matching LED luminaires from one source.

SMART LIGHTING FOR RESIDENTIAL APPLICATIONS

Our smart residential products offer a comprehensive combination of innovation, quality, reliability and user-friendliness. We provide a suitable solution for a variety of requirements that intelligent lighting has to meet.

MORE INFORMATION AND CLEVER TOOLS

For more information on LEDVANCE's extensive product portfolio and clever apps and tools that will help you in your day-to-day work go to [ledvance.com](https://www.ledvance.com)

MEANINGFUL ABBREVIATIONS NAMING IN THE LED STRIP SYSTEM

The names of the products reveal their properties:

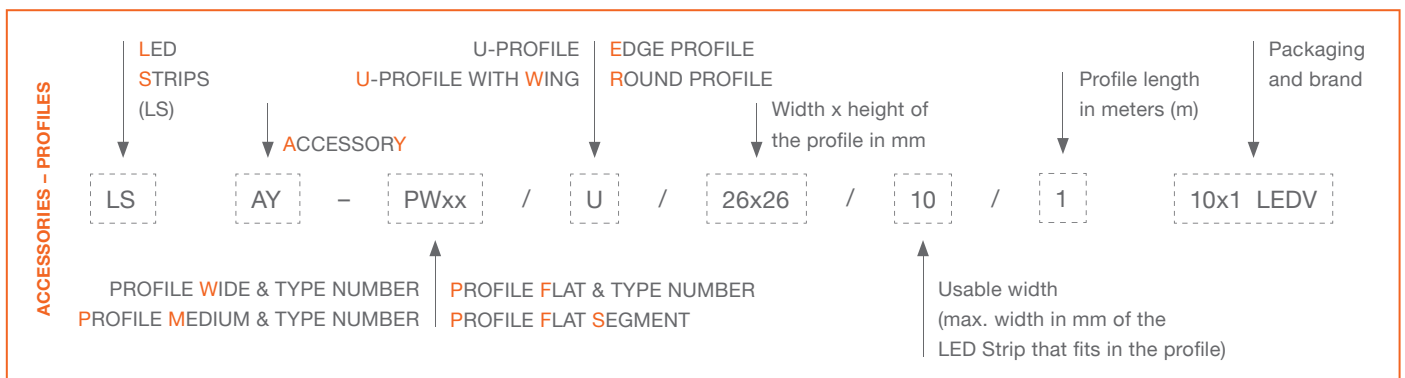
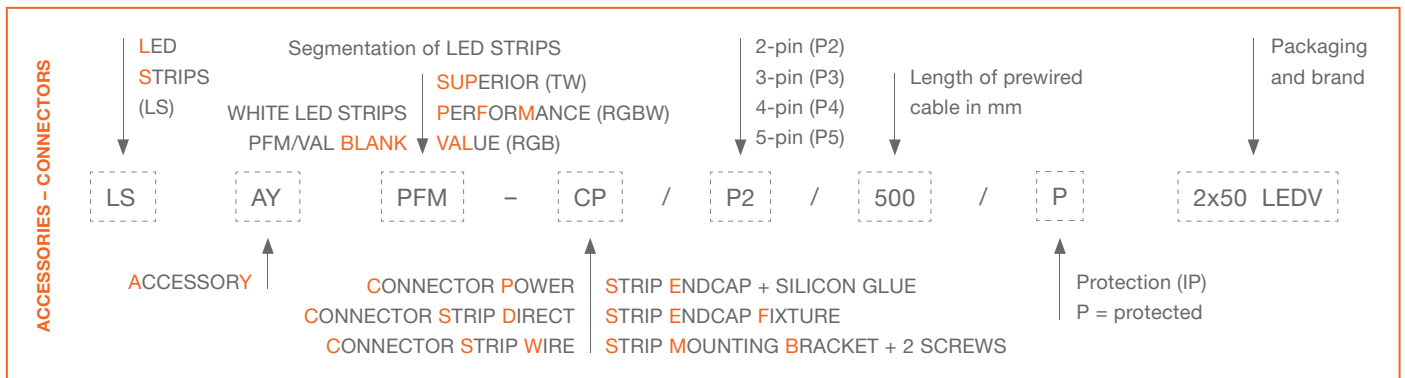
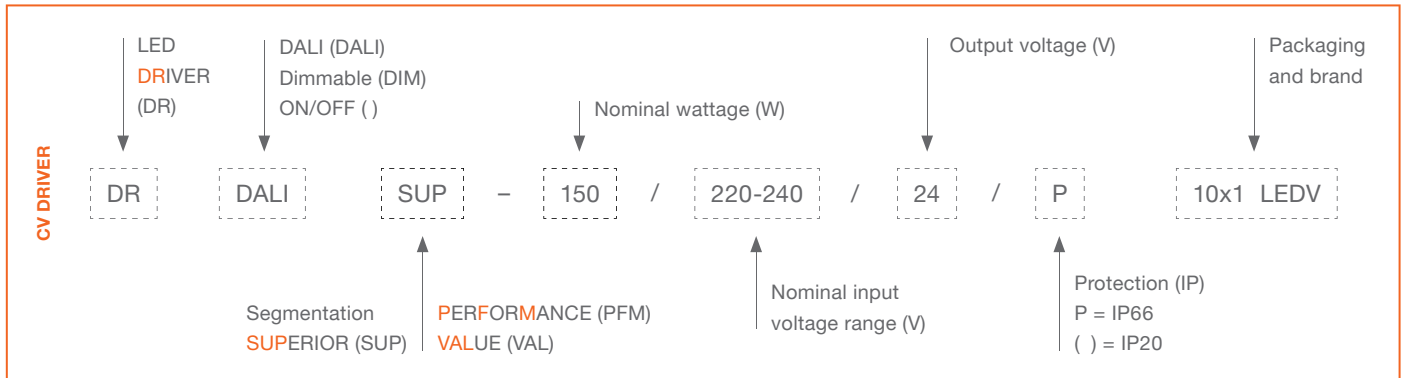
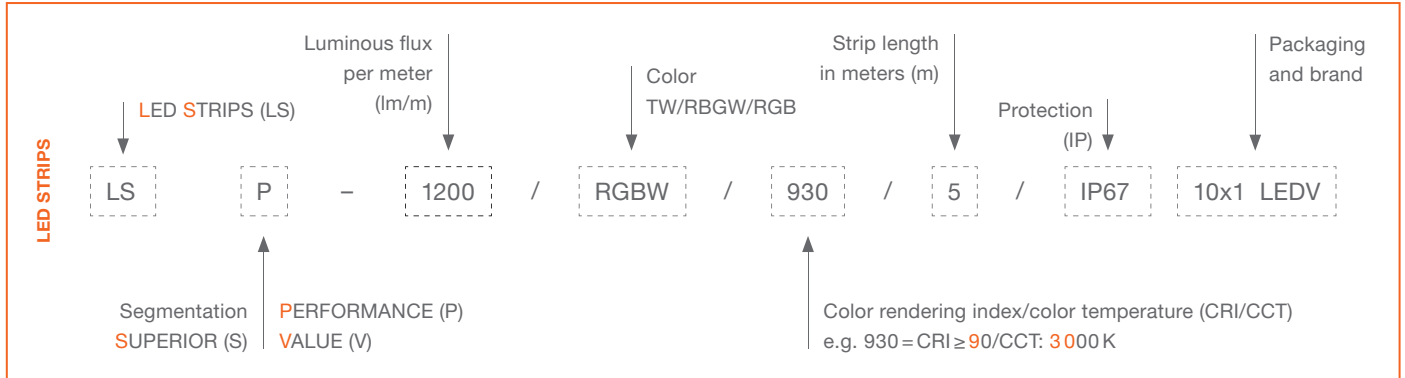

SHEDDING LIGHT

SYMBOLS AND ABBREVIATIONS

	Unprotected LED Strip		Luminous flux in lm		Dimming interface 1 – 10 V
	Protected LED Strip		Nominal wattage per meter in W		Scale Design
	Type of protection		Power in W		Operating frequency in Hz
	Color rendering index		Luminous efficacy		Ambient temperature range in °C
	MacAdam color consistency		Input voltage		Maximum operating temperature at the Tc point in °C
	Dimmable		Number of LEDs per meter		Protection class
	Dimming range in %		LED pitch in mm		Fig. no.
	Short pitch		Beam angle in °		Recommended retail price excl. VAT
	UV resistance (acc. IEC 60068-2-5)		Average period of use/life		Recommended retail price excl. VAT per meter
	Salt mist resistance (acc. IEC 60068-2-52)		Length smallest unit		Unit of Packaging (UOP)
	Color		Constant voltage		ESD protection required
	Color temperature in K		Voltage in V		Must be installed and maintained only by qualified electricians
	Luminous flux per meter		Dimming interface DALI		Do not throw away with household waste

LEDVANCE



LEDVANCE

A LEDVANCE több mint 50 képviseleti irodával, 140 országban aktív, és a világ egyik vezető világítási gyártója a professzionális és kiskereskedelmi fényforrások terén egyaránt. Az OSRAM általános világítási üzletágából alakult vállalat széles választékban kínál LED lámpatesteket a legkülönbébb alkalmazásokhoz, intelligens világítási termékeket a Smart Home – okos otthonokhoz és épületekhez, valamint a hagyományos fényforrások, a LED fényforrások, a LED szalagok és a világításvezérlő rendszerek terén az iparág legszélesebb választékával rendelkezik.

LEDVANCE Kft.
1113 – Budapest
Nagyszőlős utca 11–15.
Magyarország
LEDVANCE.HU